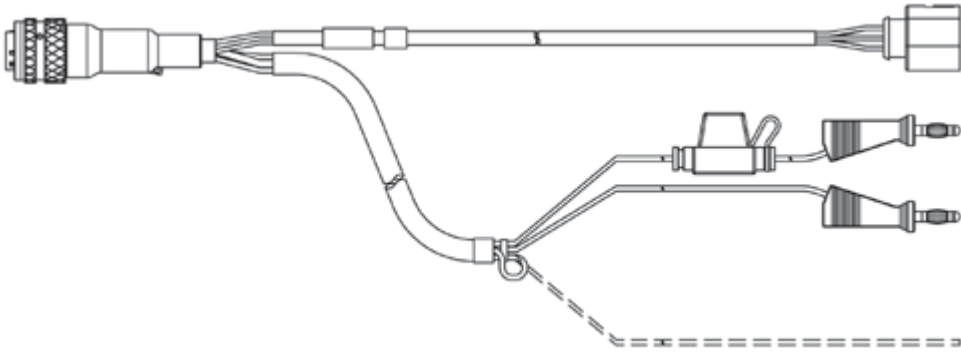

주문정보

주문명	길이	쇼트 네임	주문번호
ES630 [1]			
Lambda 모듈 (1-CH)		ES630.1	F-00K-106-296
Lambda 모듈 (1-CH) LSU 4.9 포함		ES630.1-4.9	F-00K-106-294
포함사양 1x LSUS_49 and 1x CBAL452.1-3			
보쉬 람다 센서 LSU 4.9, SR4, RB150 Code1, 300 Ohms, 1m / 3.3 ft	1.00 m 3.28 ft	LSUS_49	0-258-017-025
Lambda 센서 케이블 LSU 4.9, Souriau 8ST12-35 - RB150 (Code 1) - Banana (22mc-6fc+2mc), 3 m	3.00 m 9.84 ft	CBAL452.1-3	F-00K-106-127
			
Lambda 모듈 (1-CH) LSU ADV-G포함		ES630.1-ADV-G	F-00K-106-983
포함사양 1 x LSU_ADV_G and 1x CBAL463-3			
Lambda 센서- 가솔린 엔진을 위한 LSU ADV-G, Protection Tube TP3, Trapezoid plug, Code A7, 300 Ohms, 1m / 3.3 ft	1.00 m 3.28 ft	LSU_ADV_G	F-00K-106-409

Lambda 센서 케이블 LSU ADV, Souriau
 8ST12-35 - Trapezoid plug, Code A7 -
 Banana - BNC (22mc-7fc+2mc+2mc),
 3m / 9.8 ft

3.00 m
 9.84 ft

CBAL463.1-3

F-00K-106-310

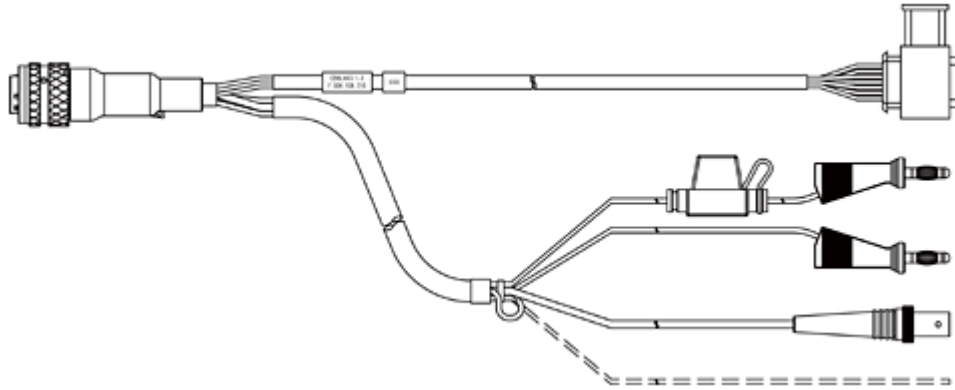

ES631 [1]

Lambda 모듈 (2-CH)

ES631.1

F-00K-106-297

Lambda 모듈 (2-CH) LSU 4.9 포함

ES631.1-4.9

F-00K-106-295

포함사양 2x LSUS_49 and 2x CBAL452.1-3

보쉬 램다 센서 LSU 4.9, SR4, RB150
 Code1, 300 Ohms, 1m / 3.3 ft

1.00 m
 3.28 ft

LSUS_49

0-258-017-025

Lambda 센서 케이블 LSU 4.9, Souriau
 8ST12-35 - RB150 (Code 1) - Banana
 (22mc-6fc+2mc), 3 m

3.00 m
 9.84 ft

CBAL452.1-3

F-00K-106-127

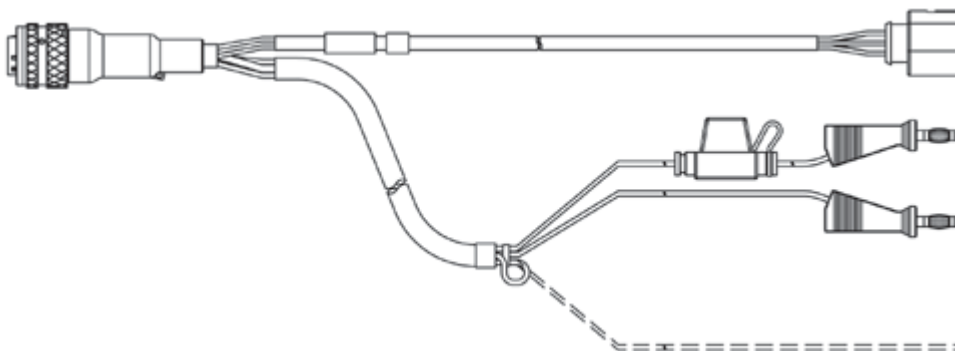

Lambda 모듈 (2-CH) LSU ADV-G 포함

ES631.1-ADV-G

F-00K-106-984

포함사양 2x LSU_ADV_G and 2x CBAL463-3

Lambda 센서- 가솔린 엔진을 위한 LSU ADV-G, Protection Tube TP3, Trapezoid plug, Code A7, 300 Ohms, 1m / 3.3 ft	1.00 m 3.28 ft	LSU_ADV_G	F-00K-106-409
--	-------------------	-----------	---------------

Lambda 센서 케이블 LSU ADV, Souriau 8ST12-35 - Trapezoid plug, Code A7 - Banana - BNC (22mc-7fc+2mc+2mc), 3m / 9.8 ft	3.00 m 9.84 ft	CBAL463.1-3	F-00K-106-310
---	-------------------	-------------	---------------

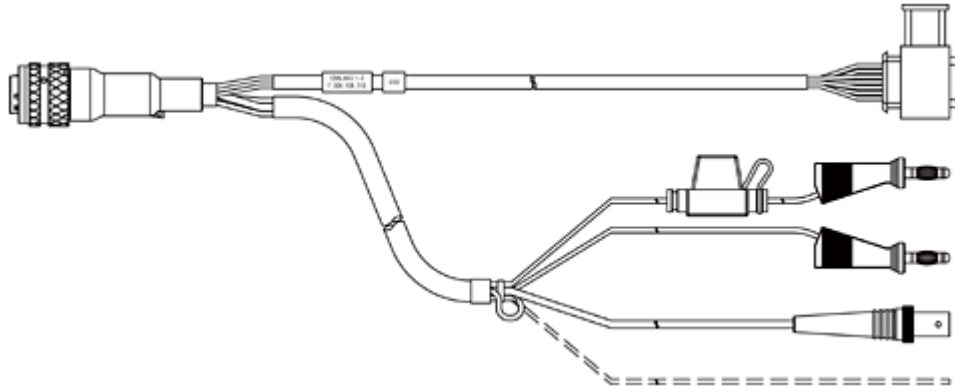

ES635 [1]

Lambda 모듈 (1-CH)	ES635.1	F-00K-106-675
------------------	---------	---------------

Lambda 모듈 (1-CH), LSU 4.9포함	ES635.1-4.9	F-00K-106-673
-----------------------------	-------------	---------------

포함사양 1x LSUS_49, 1x CBAL452.1-3, and 1x PS63

보쉬 람다 센서 LSU 4.9, SR4, RB150 Code1, 300 Ohms, 1m / 3.3 ft	1.00 m 3.28 ft	LSUS_49	0-258-017-025
--	-------------------	---------	---------------

Lambda 센서 케이블 LSU 4.9, Souriau 8ST12-35 - RB150 (Code 1) - Banana (22mc-6fc+2mc), 3 m	3.00 m 9.84 ft	CBAL452.1-3	F-00K-106-127
---	-------------------	-------------	---------------

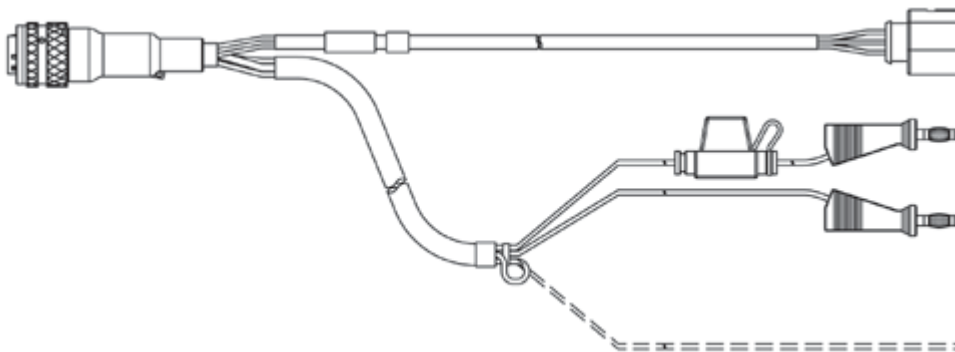

압력 센서 PS63를 위한 확장 케이블	PS63	F-00K-106-679
-----------------------	------	---------------

Lambda 모듈 (1-CH) ,LSU ADV-G 포함	ES635.1-ADV-G	F-00K-106-677
--------------------------------	---------------	---------------

포함사양 1x LSU_ADV_G, 1x CBAL463-3, and 1x PS63

Lambda 센서- 가솔린 엔진을 위한 LSU ADV-G, Protection Tube TP3, Trapezoid plug, Code A7, 300 Ohms, 1m / 3.3 ft	1.00 m 3.28 ft	LSU_ADV_G	F-00K-106-409
--	-------------------	-----------	---------------

Lambda 센서 케이블 LSU ADV, Souriau 8ST12-35 - Trapezoid plug, Code A7 - Banana - BNC (22mc-7fc+2mc+2mc), 3m / 9.8 ft	3.00 m 9.84 ft	CBAL463.1-3	F-00K-106-310
--	-------------------	-------------	---------------

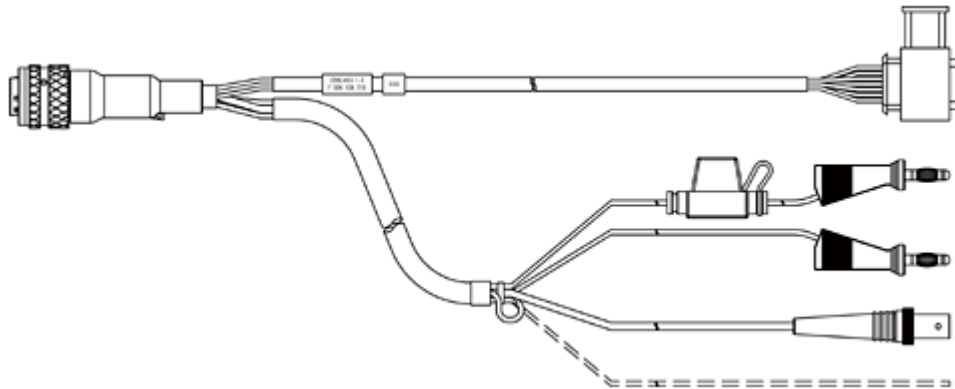

압력 센서 PS63를 위한 확장 케이블	PS63	F-00K-106-679
-----------------------	------	---------------

ES636 [1]

Lambda 모듈 (2-CH)	ES636.1	F-00K-106-676
------------------	---------	---------------

Lambda 모듈 (2-CH), LSU 4.9포함	ES636.1-4.9	F-00K-106-674
-----------------------------	-------------	---------------

포함사양 2x LSUS_49, 2x CBAL452.1-3, and 2x PS63

보쉬 람다 센서 LSU 4.9, SR4, RB150 Code1, 300 Ohms, 1m / 3.3 ft	1.00 m 3.28 ft	LSUS_49	0-258-017-025
---	-------------------	---------	---------------

Lambda 센서 케이블 LSU 4.9, Souriau 8ST12-35 - RB150 (Code 1) - Banana (22mc-6fc+2mc), 3 m	3.00 m 9.84 ft	CBAL452.1-3	F-00K-106-127
---	-------------------	-------------	---------------

Souriau 소켓을 먼지로부터 보호하며 비
용 대비 효과가 뛰어난 캡

CAP_SOURIAU_8STA F-00K-105-303

독립적인 운영체제 [2,4]

전원 공급 케이블, Lemo 1B FGL -Banana 2.00 m CBP630.1-2 F-00K-106-312
(8mc-2mc), 2m 6.56 ft

전원 공급 케이블, Lemo 1B FGL - Safety 2.00 m CBP6305.1-2 F-00K-110-022
Banana (8mc-2mc), 2m 6.56 ft

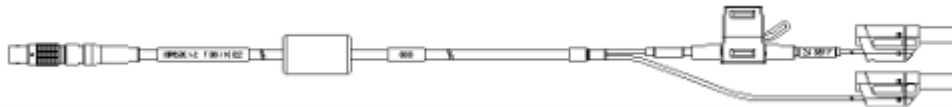

PC 커넥션 및 전원 공급 [3,4,5,7]

이더넷 PC 커넥션 및 전원 공급 케이블, 3.00 m CBEP410.1-3 F-00K-104-927
Lemo 1B FGL - RJ45 - Banana (8fc- 9.84 ft
8mc+2mc), 3 m

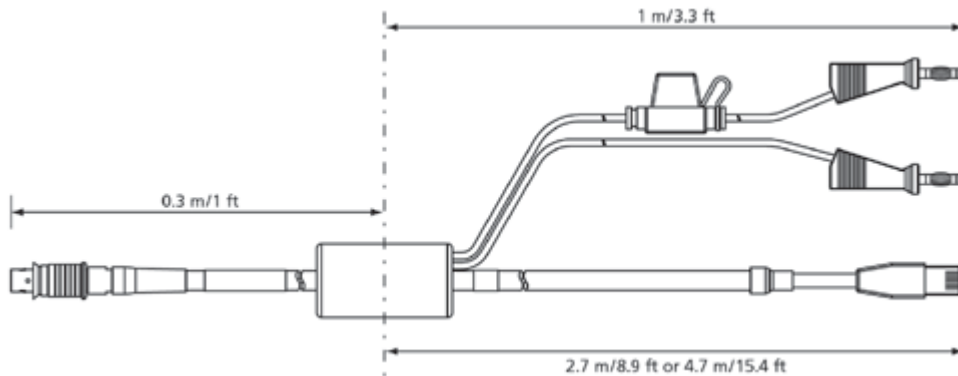

이더넷 PC 커넥션 및 전원 공급 케이블, 3.00 m CBEP4105.1-3 F-00K-110-026
Lemo 1B FGL - RJ45 - Safety Banana 9.84 ft
(8fc-8mc+2mc), 3 m

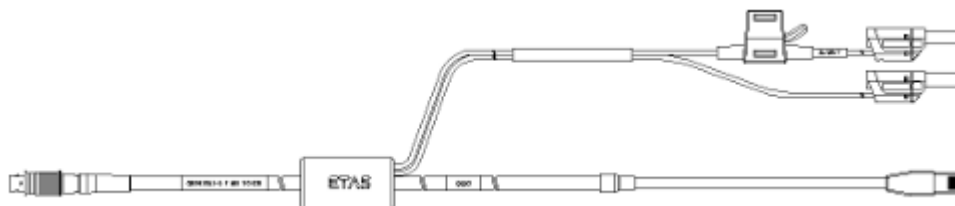

이더넷 PC 커넥션 및 전원 공급 케이블, 5.00 m CBEP415.1-5 F-00K-105-680
Power Feeder는 PC에 근접, Lemo 1B 16.40 ft
FGL - RJ45 - Banana (8fc-8mc+2mc), 5 m

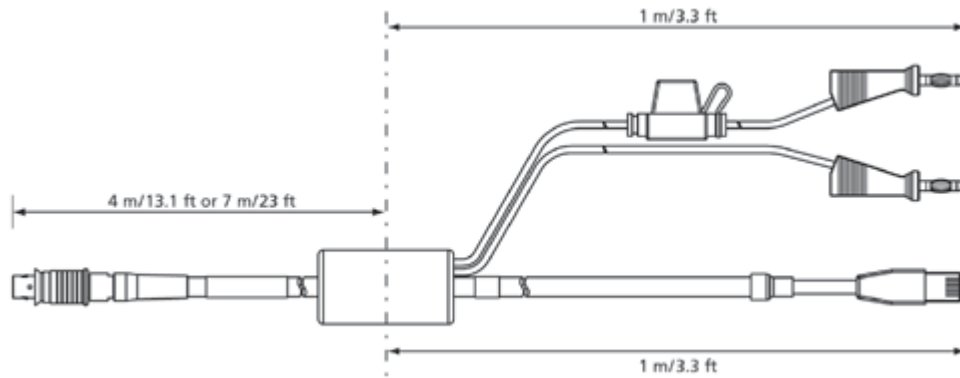

이더넷 PC 커넥션 및 전원 공급 케이블,
Power Feeder는 PC에 근접, Lemo 1B
FGL - RJ45 - Safety Banana (8fc-
8mc+2mc), 5 m

5.00 m CBEP4155.1-5 F-00K-110-027
16.40 ft

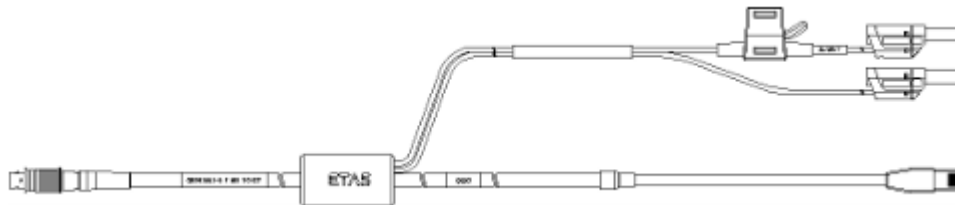

ES592, ES593과의 커넥션 및 파워 서플라이, 또는 ES595 인터페이스 모듈 / ES600 네트워크 모듈 [3,4,5,7]

이더넷 커넥션 및 전원 공급 케이블,
Lemo 1B FGF - Lemo 1B FGL - Banana
(8mc-8fc+2mc), 3 m

3.00 m CBEP420.1-3 F-00K-105-292
9.84 ft

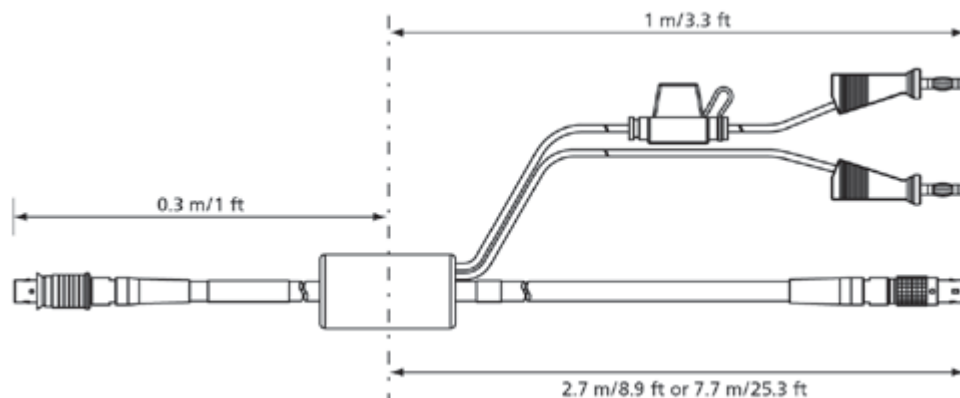

이더넷 커넥션 및 전원 공급 케이블,
Lemo 1B FGF - Lemo 1B FGL - Safety
Banana (8mc-8fc+2mc), 3 m

3.00 m CBEP4205.1-3 F-00K-110-041
9.84 ft

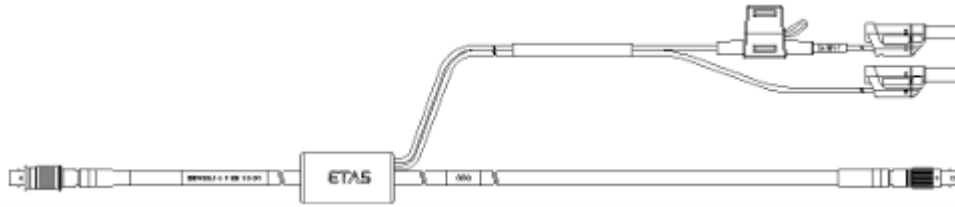

이더넷 커넥션 및 전원 공급 케이블,
Lemo 1B FGF - Lemo 1B FGL - Banana
(8mc-8fc+2mc), 3 m

3.00 m	CBEP425.1-3	F-00K-105-972
9.84 ft		

이더넷 커넥션 및 전원 공급 케이블,
Lemo 1B FGF - Lemo 1B FGL - Safety
Banana (8mc-8fc+2mc), 3 m

3.00 m	CBEP4255.1-3	F-00K-110-029
9.84 ft		

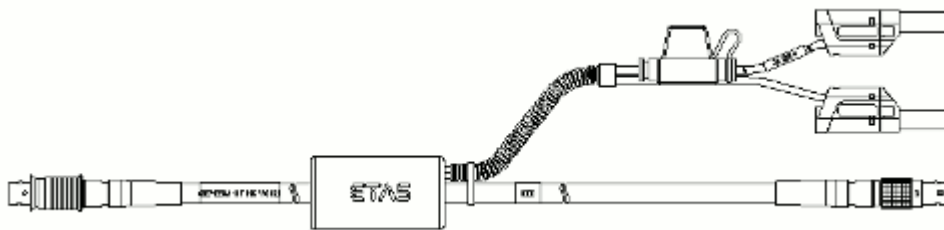

ES400 및 ES63x 측정 모듈과의 커넥션, 전원 공급 [3,4,6,8]

이더넷 체인 커넥션 및 전원 공급 케이블,
Lemo 1B FGL - Lemo 1B FGA - Banana
(8fc-8mc+2mc), 0m5

0.50 m	CBEP430.1-0m5	F-00K-104-928
1.64 ft		

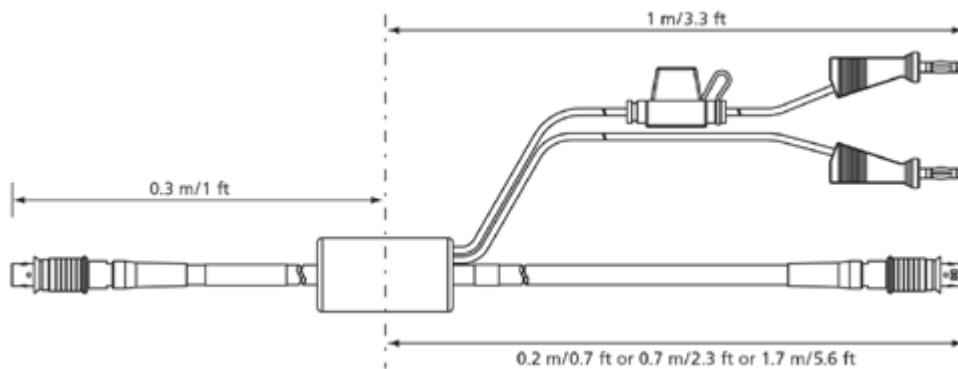

이더넷 체인 커넥션 및 전원 공급 케이블,
Lemo 1B FGL - Lemo 1B FGA - Safety
Banana (8fc-8mc+2mc), 0m5

0.50 m	CBEP4305.1-0m5	F-00K-110-030
1.64 ft		

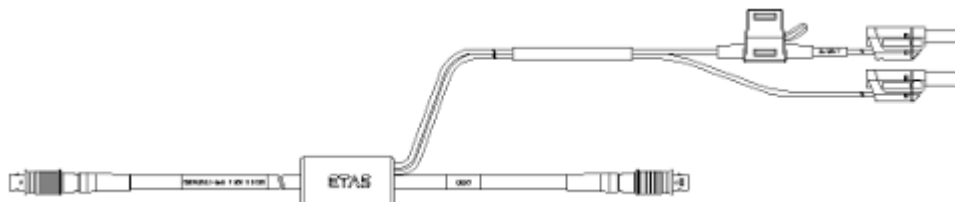

ES600 네트워크 모듈과의 커넥션 [3,4,5]

이더넷 PC 커넥션 케이블, Lemo 1B FGF - 3.00 m CBE400.2-3 F-00K-104-920
 Lemo 1B FGL (8mc-8fc), 3 m 9.84 ft

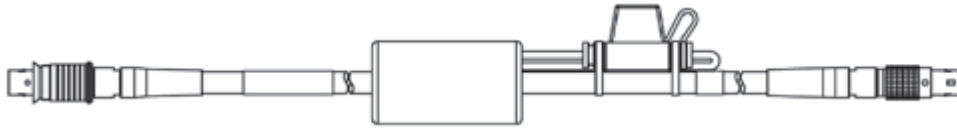

이더넷 PC 커넥션 케이블,하이 플렉시블,
 Lemo 1B FGF - Lemo 1B FGL (8mc-8fc), 0.50 m CBE4011-0m5 F-00K-106-128
 0m5 1.64 ft

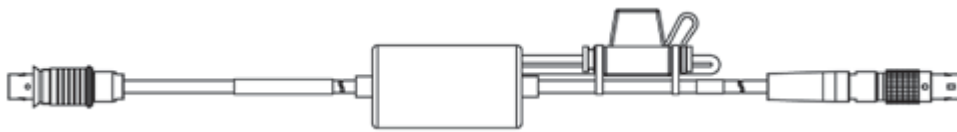

ES400 또는 ES63x 측정 모듈과의 커넥션 [3,6]

이더넷 체인 커넥션 케이블, Lemo 1B FGA 0.45 m CBE430.1-0m45 F-00K-104-923
 - Lemo 1B FGL (8mc-8fc), 0m45 1.48 ft



이더넷 체인 커넥션 케이블,하이 플렉시블,
 Lemo 1B FGA - Lemo 1B FGL (8mc-8fc), 0.14 m CBE4311-0m14 F-00K-105-676
 0m14 0.46 ft



이더넷 체인 커넥션 케이블,하이 플렉시블,
 Lemo 1B FGA - Lemo 1B FGL (8mc-8fc), 0.30 m CBE4311-0m3 F-00K-105-685
 0m3 0.98 ft



이더넷 익스텐션 케이블, Lemo 1B PHL - 3.00 m CBEX400.1-3 F-00K-105-294
 Lemo 1B FGL (8mc-8fc), 3 m 9.84 ft



SMB 커넥션

SMB 커넥션 Y-Cable, DSUB - DSUB - DSUB (15fc-9mc-9mc), 0m3	0.30 m 0.98 ft	CBAS100.1-0m3	F-00K-106-313
---	-------------------	---------------	---------------

LSU 4.2 Lambda 산소 센서 및 LSU 4.2 / LSU 4.7 센서 케이블 [9]

보쉬 Lambda 센서 LSU 4.2 for Lambda Meter with universal connector, 1m	1.00 m 3.28 ft	LSUS_42	0-258-007-151
--	-------------------	---------	---------------

Lambda 센서 케이블 LSU 4.2 및 LSU 4.7, Souriau 8ST12-35 - RB130ft - Banana - BNC (22mc-6fc+2mc+2mc), 3m	3.00 m 9.84 ft	CBAL410.1-3	F-00K-106-302
---	-------------------	-------------	---------------

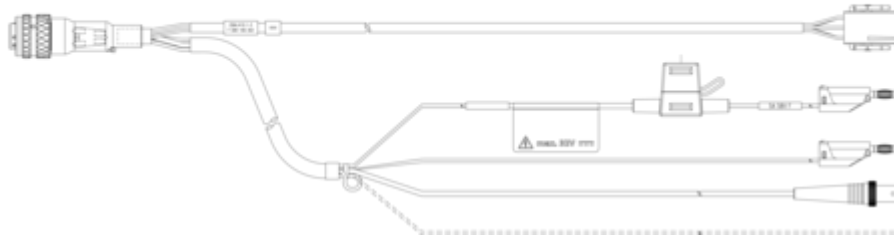

Lambda 센서 케이블 LSU 4.2 및 LSU 4.7, Souriau 8ST12-35 - RB130ft - Safety Banana - BNC (22mc-6fc+2mc+2mc), 3m	3.00 m 9.84 ft	CBAL4105.1-3	F-00K-110-033
--	-------------------	--------------	---------------

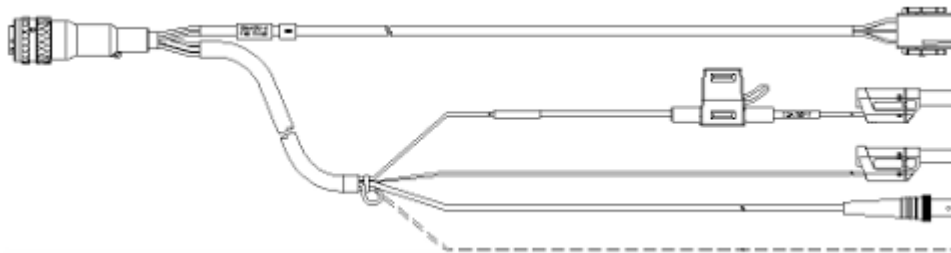

LSU 4.9 Lambda 산소 센서 및 센서 케이블 [9]

보쉬 람다 센서 LSU 4.9, SR4, RB150 Code1, 300 Ohms, 1m / 3.3 ft	1.00 m 3.28 ft	LSUS_49	0-258-017-025
---	-------------------	---------	---------------

Lambda 센서 케이블 LSU 4.9, Souriau 8ST12-35 - RB150 (Code 1) - Banana - BNC (22mc-6fc+2mc+2mc), 3m	3.00 m 9.84 ft	CBAL451.1-3	F-00K-105-926
--	-------------------	-------------	---------------

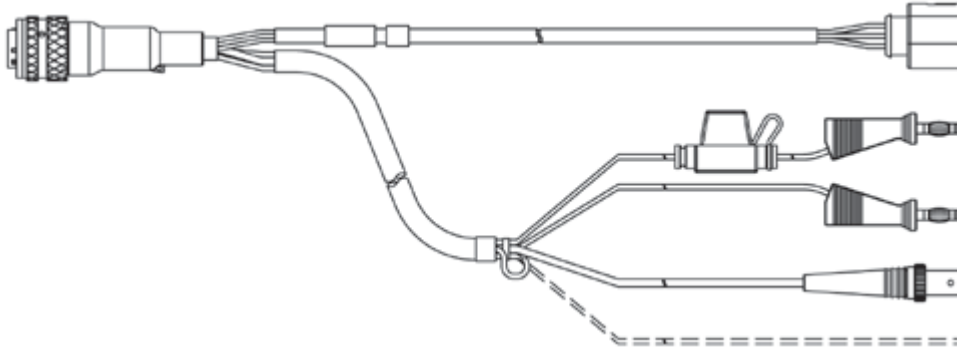

Lambda 센서 케이블 LSU 4.9, Souriau
 8ST12-35 - RB150 (Code 1) - Safety 3.00 m CBAL4515.1-3 F-00K-110-038
 Banana - BNC (22mc-6fc+2mc+2mc), 3 9.84 ft
 m

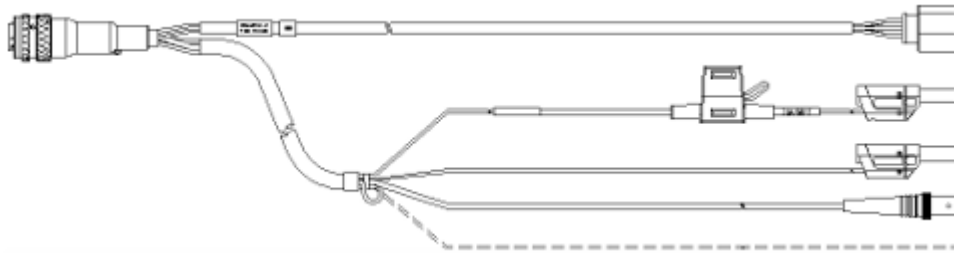

Lambda 센서 케이블 LSU 4.9, Souriau
 8ST12-35 - RB150 (Code 1) - Banana 3.00 m CBAL452.1-3 F-00K-106-127
 (22mc-6fc+2mc), 3 m 9.84 ft

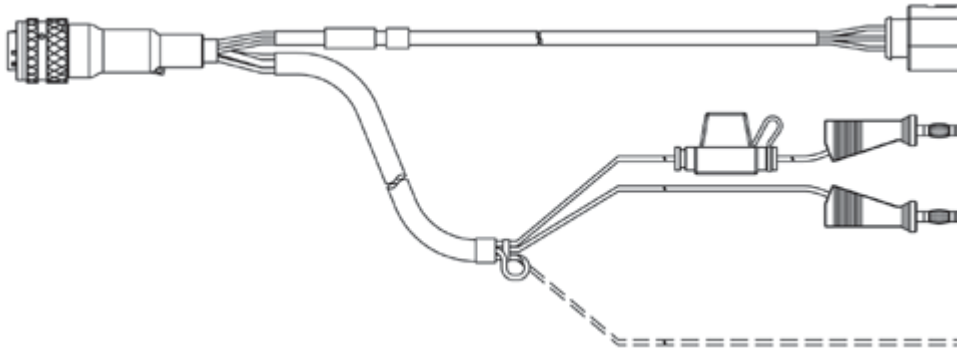

Lambda 센서 케이블 LSU 4.9, Souriau
 8ST12-35 - RB150 (Code 1) - Safety 3.00 m CBAL4525.1-3 F-00K-110-039
 Banana (22mc-6fc+2mc), 3 m 9.84 ft

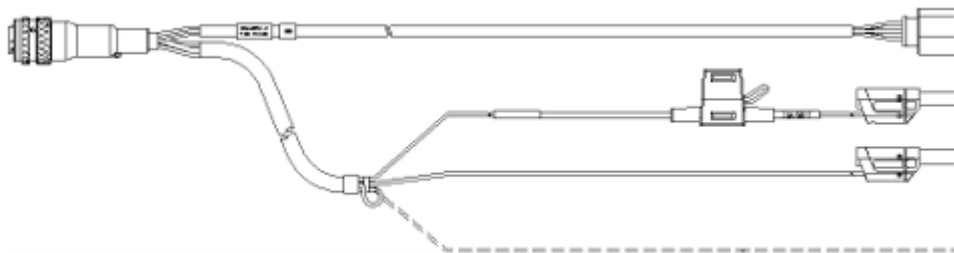

Lambda 센서 케이블 LSU 4.9, Souriau
 8ST12-35 - RB150 (Code A) - Banana - 5.00 m
 BNC (22mc-6fc+2mc+2mc), 5m / 16.4 16.40 ft AS_CBAL455.1-5 F-00K-106-308
 ft

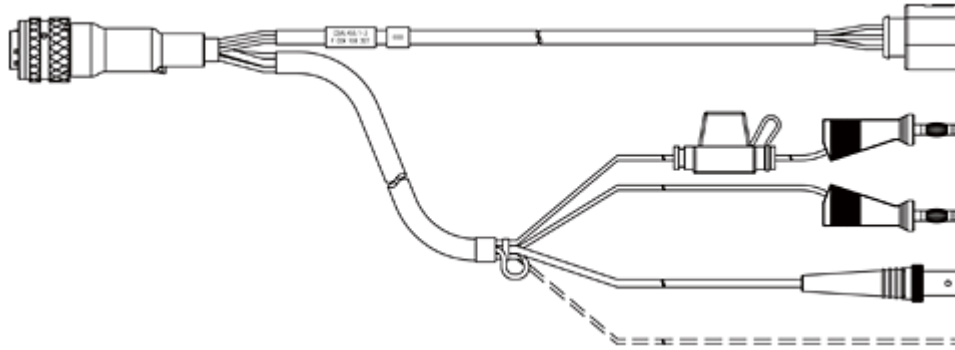

LSU ADV Lambda 산소 센서 및 센서 케이블 [10]

Lambda 센서- 가솔린 엔진을 위한 LSU
 ADV-G, Protection Tube TP3, Trapezoid 1.00 m
 plug, Code A7, 300 Ohms, 1m / 3.3 ft 3.28 ft LSU_ADV_G F-00K-106-409

Lambda 센서 케이블 LSU ADV, Souriau
 8ST12-35 - Trapezoid plug, Code A7 - 3.00 m
 Banana - BNC (22mc-7fc+2mc+2mc), 9.84 ft
 3m / 9.8 ft CBAL463.1-3 F-00K-106-310

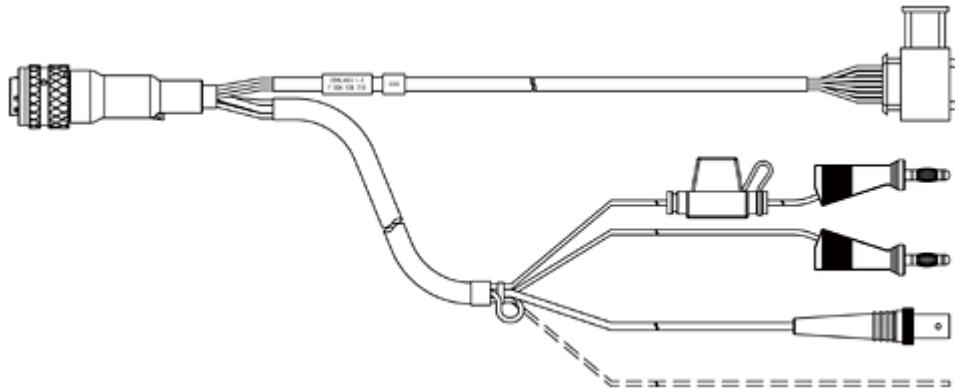

Lambda 센서 케이블 LSU ADV, Souriau
 8ST12-35 - Trapezoid plug, Code A7 - 3.00 m
 Safety Banana - BNC (22mc- 9.84 ft
 7fc+2mc+2mc), 3m / 9.8 ft CBAL4635.1-3 F-00K-110-035

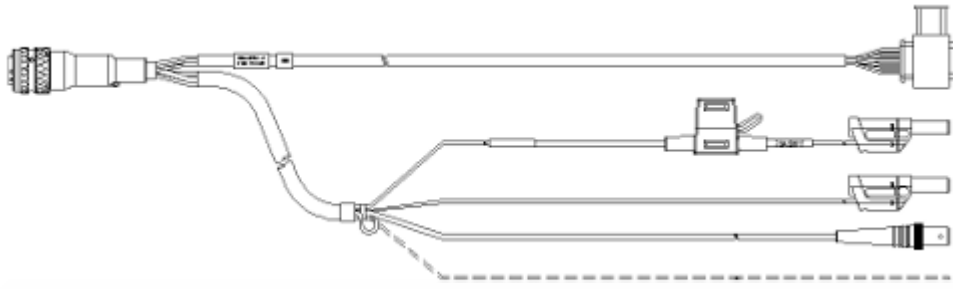

NTK ZFAS[®]-U2 Lambda 산소 센서 케이블 [11]

Lambda 센서 케이블 ZFAS [®] -U2, Souriau 8ST12-35 - RB150 (Code 1) - Banana (22mc-6fc+2mc), 3m	3.00 m 9.84 ft	CBAL472.1-3	F-00K-107-313
--	-------------------	-------------	---------------

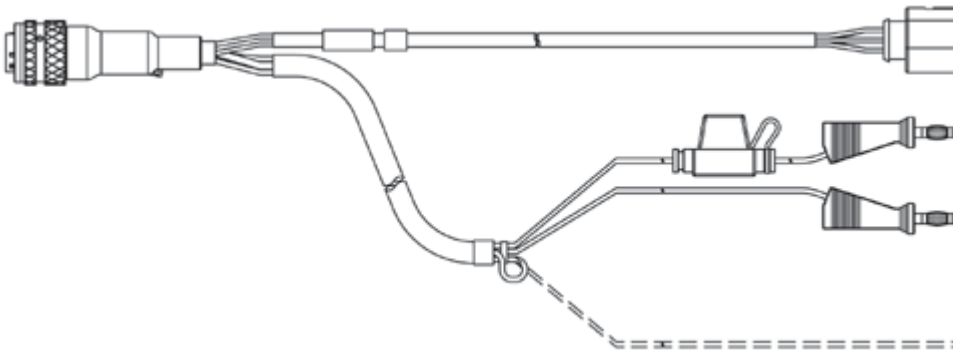

Lambda 센서 케이블 ZFAS [®] -U2, Souriau 8ST12-35 - RB150 (Code 1) - Safety Banana (22mc-6fc+2mc), 3m	3.00 m 9.84 ft	CBAL4725.1-3	F-00K-110-040
---	-------------------	--------------	---------------

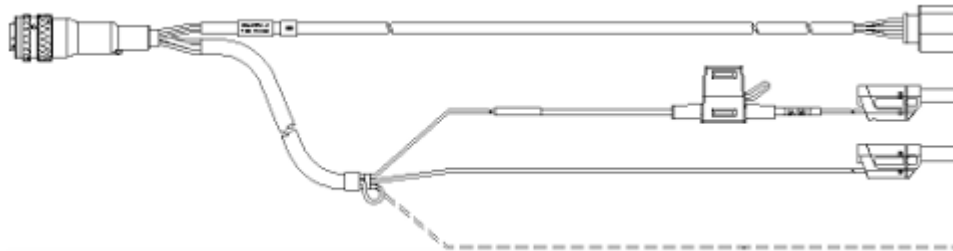

외부 압력 센서 및 확장 케이블 (ES635/ES636를 위한 추가 액세서리)

압력 센서 PS63를 위한 확장 케이블	PS63	F-00K-106-679
압력 센서 PS63를 위한 확장 케이블	CBAX100.1-3	F-00K-106-680

주석

- [1] 전원 케이블 및 이더넷 케이블은 배송 시 불포함
 - [2] 온도 범위 -40°C (-40°F) to +70°C (158°F)
 - [3] 온도 범위 -40°C (-40°F) to +125°C (257°F)
 - [4] 역방향 극성, 로드 덤프 보호 및 표준 퓨즈 포함
 - [5] IP67 측정 모듈 체인에 대해 지정된 Lemo 커넥터
 - [6] IP67 양쪽에 모두 지정된 Lemo 커넥터
 - [7] ES600/ES610/ES611/ES620/ES650에 호환되지 않음 (CBEP120 전원 공급 케이블은 ES6xx와 함께 사용)
 - [8] ES59x, ES6xx, ES11xx에 호환되지 않음 (CBE130 또는 CBE140 커넥션 케이블은 상기 디바이스와 함께 사용)
 - [9] 센서 유형 식별을위한 TEDS는 센서 케이블에 위치
 - [10] 센서 유형 식별을위한 TEDS는 Lamda 산소 센서 케이블에 위치
 - [11] NTK ZFAS®-U2 lambda 산소 센서는 이타스에서 제공하지 않음
- 커스텀 케이블은 고객의 사양에 따라 생산될 수 있습니다. 커스텀 케이블에 대한 더 자세한 정보는 [가까운 이타스 영업 담당자에게 문의하십시오.](#)

