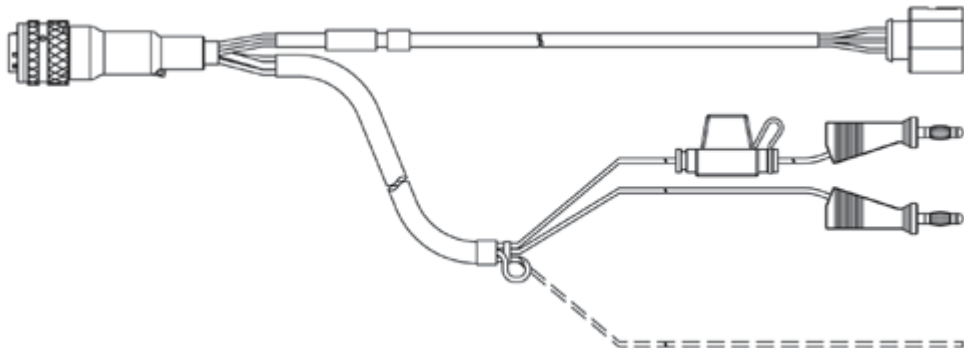

Bestellinformationen

Artikelbezeichnung	Länge	Kurzname	Bestellnummer
ES630 [1]			
Lambda-Modul (1 Kanal)		ES630.1	F-00K-106-296
Lambda-Modul (1 Kanal) inkl. LSU 4.9		ES630.1-4.9	F-00K-106-294
enthält 1x LSUS_49 und 1x CBAL452.1-3			
Bosch Lambdasonde LSU 4.9, SR4, RB150 Code1-Stecker, 300 Ohm, 1 m	1.00 m 3.28 ft	LSUS_49	0-258-017-025
Lambdasondenkabel LSU 4.9, Souriau 8ST12-35 - RB150 (Code 1) - Bananenstecker (22mc-6fc+2mc), 3 m	3.00 m 9.84 ft	CBAL452.1-3	F-00K-106-127
			
Lambda-Modul (1 Kanal) inkl. LSU ADV-G		ES630.1-ADV-G	F-00K-106-983

enthält 1x LSU_ADV_G und 1x CBAL463-3

Lambdasonde LSU ADV-G für Benzinmotoren, Schutzröhre TP3, Trapez-Stecker, Code A7, 300 Ohm, 1m / 3.3 ft	1.00 m 3.28 ft	LSU_ADV_G	F-00K-106-409
--	-------------------	-----------	---------------

Lambdasondenkabel LSU ADV, Souriau 8ST12-35 - Trapez-Stecker, Code A7 - Bananenstecker- BNC (22mc-7fc+2mc+2mc), 3m / 9.8 ft	3.00 m 9.84 ft	CBAL463.1-3	F-00K-106-310
--	-------------------	-------------	---------------

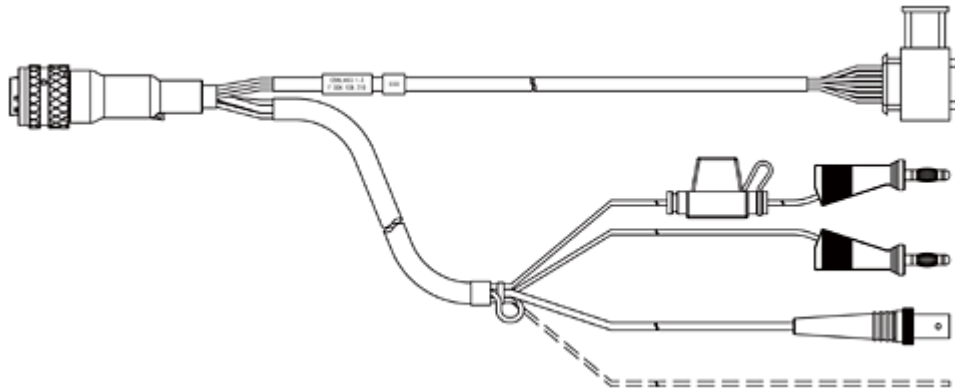

ES631 [1]

Lambda-Modul (2 Kanäle)	ES631.1	F-00K-106-297
-------------------------	---------	---------------

Lambda-Modul (2 Kanäle) inkl. LSU 4.9	ES631.1-4.9	F-00K-106-295
--	-------------	---------------

enthält 2x LSUS_49 und 2x CBAL452.1-3

Bosch Lambdasonde LSU 4.9, SR4, RB150 Code1-Stecker, 300 Ohm, 1 m	1.00 m 3.28 ft	LSUS_49	0-258-017-025
--	-------------------	---------	---------------

Lambdasondenkabel LSU 4.9, Souriau 8ST12-35 - RB150 (Code 1) - Bananenstecker (22mc-6fc+2mc), 3 m	3.00 m 9.84 ft	CBAL452.1-3	F-00K-106-127
--	-------------------	-------------	---------------

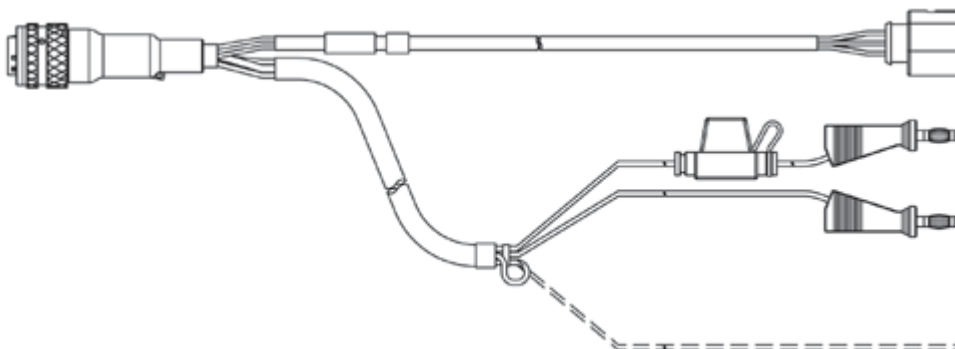

Lambda-Modul (2 Kanäle) inkl. LSU ADV-G	ES6311-ADV-G	F-00K-106-984
--	--------------	---------------

enthält 2x LSU_ADV_G und 2x CBAL463-3

Lambdasonde LSU ADV-G für Benzinmotoren, Schutzröhre TP3, Trapez-Stecker, Code A7, 300 Ohm, 1m / 3.3 ft	1.00 m 3.28 ft	LSU_ADV_G	F-00K-106-409
--	-------------------	-----------	---------------

Lambdasondenkabel LSU ADV, Souriau 8ST12-35 - Trapez-Stecker, Code A7 - Bananenstecker- BNC (22mc-7fc+2mc+2mc), 3m / 9.8 ft	3.00 m 9.84 ft	CBAL463.1-3	F-00K-106-310
--	-------------------	-------------	---------------

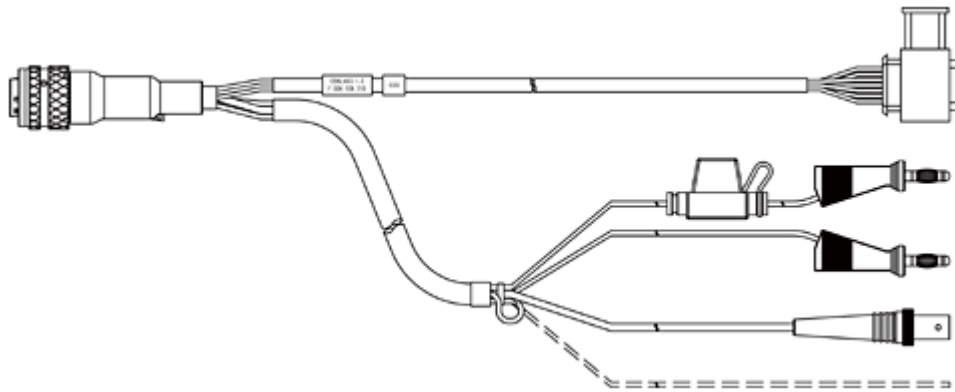

ES635 [1]

Lambda-Modul (1 Kanal)	ES635.1	F-00K-106-675
------------------------	---------	---------------

Lambda-Modul (1 Kanal) inkl. LSU 4.9	ES635.1-4.9	F-00K-106-673
--------------------------------------	-------------	---------------

enthält 1x LSUS_49, 1x CBAL452.1-3 und 1x PS63

Bosch Lambdasonde LSU 4.9, SR4, RB150 Code1-Stecker, 300 Ohm, 1 m	1.00 m 3.28 ft	LSUS_49	0-258-017-025
--	-------------------	---------	---------------

Lambdasondenkabel LSU 4.9, Souriau 8ST12-35 - RB150 (Code 1) - Bananenstecker (22mc-6fc+2mc), 3 m	3.00 m 9.84 ft	CBAL452.1-3	F-00K-106-127
--	-------------------	-------------	---------------

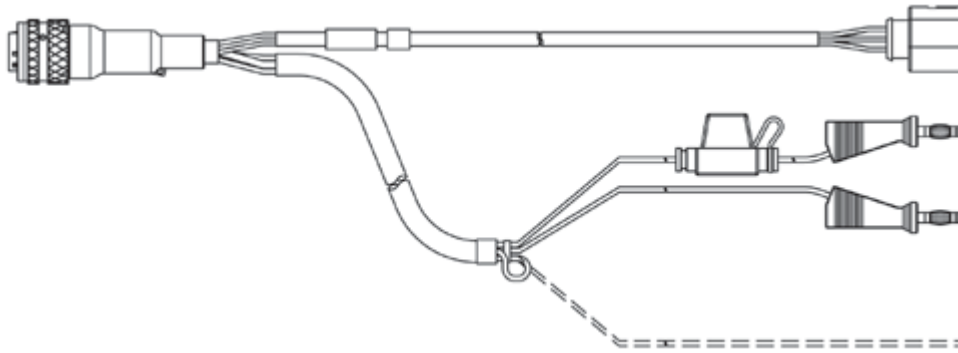

Drucksensor	PS63	F-00K-106-679
-------------	------	---------------

Lambda-Modul (1 Kanal) inkl. LSU ADV-G	ES635.1-ADV-G	F-00K-106-677
--	---------------	---------------

enthält 1x LSU_ADV_G, 1x CBAL463-3 und 1x PS63

Lambdasonde LSU ADV-G für Benzinmotoren, Schutzröhre TP3, Trapez-Stecker, Code A7, 300 Ohm, 1m / 3.3 ft	1.00 m 3.28 ft	LSU_ADV_G	F-00K-106-409
---	-------------------	-----------	---------------

Lambdasondenkabel LSU ADV, Souriau 8ST12-35 - Trapez-Stecker, Code A7 - Bananenstecker- BNC (22mc-7fc+2mc+2mc), 3m / 9.8 ft	3.00 m 9.84 ft	CBAL463.1-3	F-00K-106-310
---	-------------------	-------------	---------------

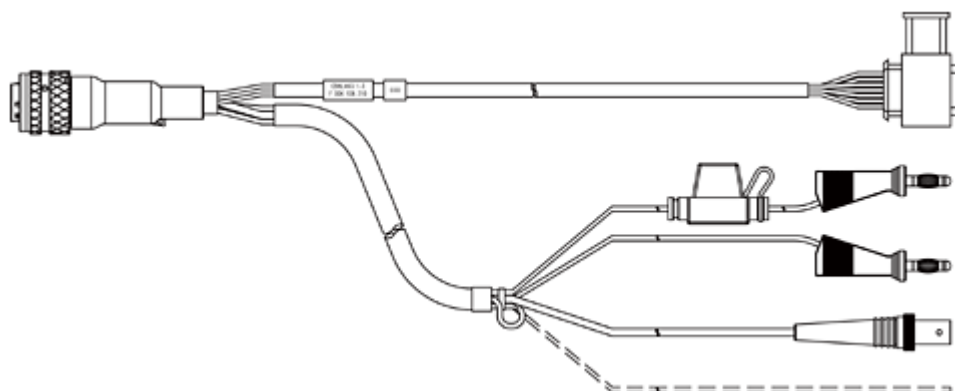

Drucksensor	PS63	F-00K-106-679
-------------	------	---------------

ES636 [1]

Lambda-Modul (2 Kanäle)	ES636.1	F-00K-106-676
-------------------------	---------	---------------

Lambda-Modul (2 Kanäle) inkl. LSU 4.9	ES636.1-4.9	F-00K-106-674
---------------------------------------	-------------	---------------

enthält 2x LSU_49, 2x CBAL452.1-3 und 2x PS63

Bosch Lambdasonde LSU 4.9, SR4, RB150 Code1-Stecker, 300 Ohm, 1 m	1.00 m 3.28 ft	LSUS_49	0-258-017-025
--	-------------------	---------	---------------

Lambdasondenkabel LSU 4.9, Souriau 8ST12-35 - RB150 (Code 1) - Bananenstecker (22mc-6fc+2mc), 3 m	3.00 m 9.84 ft	CBAL452.1-3	F-00K-106-127
--	-------------------	-------------	---------------

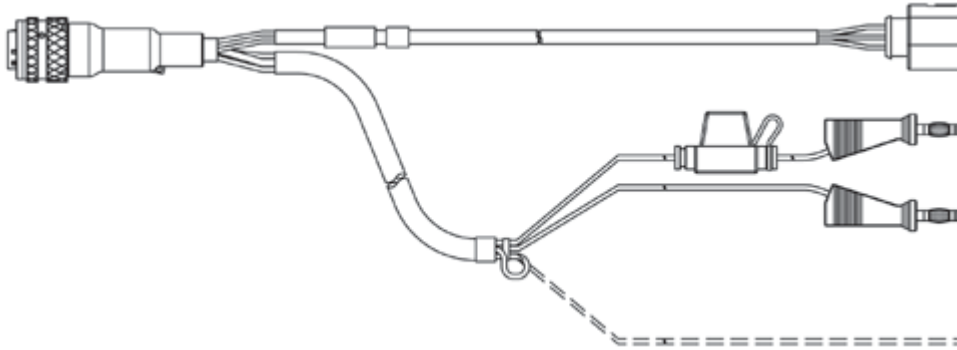

Drucksensor	PS63	F-00K-106-679
-------------	------	---------------

Lambda-Modul (2 Kanäle) inkl. LSU ADV-G	ES636.1-ADV-G	F-00K-106-678
--	---------------	---------------

enthält 2x LSU_ADV_G, 2x CBAL463-3 und 2x PS63

Lambdasonde LSU ADV-G für Benzinmotoren, Schutzröhre TP3, Trapez-Stecker, Code A7, 300 Ohm, 1m / 3.3 ft	1.00 m 3.28 ft	LSU_ADV_G	F-00K-106-409
--	-------------------	-----------	---------------

Lambdasondenkabel LSU ADV, Souriau 8ST12-35 - Trapez-Stecker, Code A7 - Bananenstecker- BNC (22mc-7fc+2mc+2mc), 3m / 9.8 ft	3.00 m 9.84 ft	CBAL463.1-3	F-00K-106-310
--	-------------------	-------------	---------------

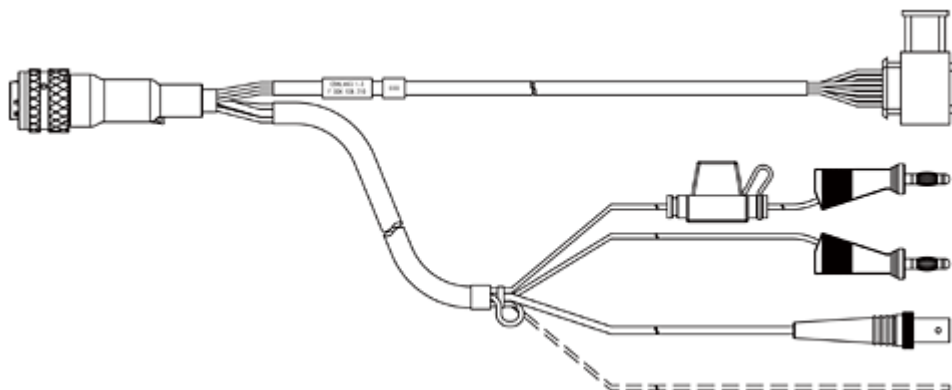

Drucksensor

PS63

F-00K-106-679

Optionales Zubehör für ES630 / ES631 / ES635 / ES636

Preiswerter Schutz von offenen Lemo
1B Anschlüssen gegen Schmutz

CAP_LEMO_1B_LC

F-00K-105-683



Preiswerter Schutz von offenen
Souriau Anschlüssen gegen Schmutz

CAP_SOURIAU_8STA F-00K-105-303

Standalone Betrieb [2,4]

Stromversorgungskabel, Lemo 1B FGL
-Banannenstecker (8mc-2mc), 2m

2.00 m
6.56 ft

CBP630.1-2

F-00K-106-312

Stromversorgungskabel, Lemo 1B FGL
- Sicherheitsbananenstecker (8mc-
2mc), 2m

2.00 m
6.56 ft

CBP6305.1-2

F-00K-110-022

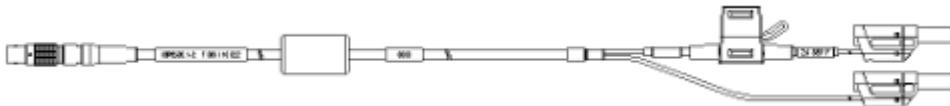

PC-Verbindung und Stromversorgung [3,4,5,7]

Ethernet-PC-Verbindungs- und
Stromversorgungskabel, Lemo 1B FGL
- RJ45 - Bananenstecker (8fc-
8mc+2mc), 3 m

3.00 m
9.84 ft

CBEP410.1-3

F-00K-104-927

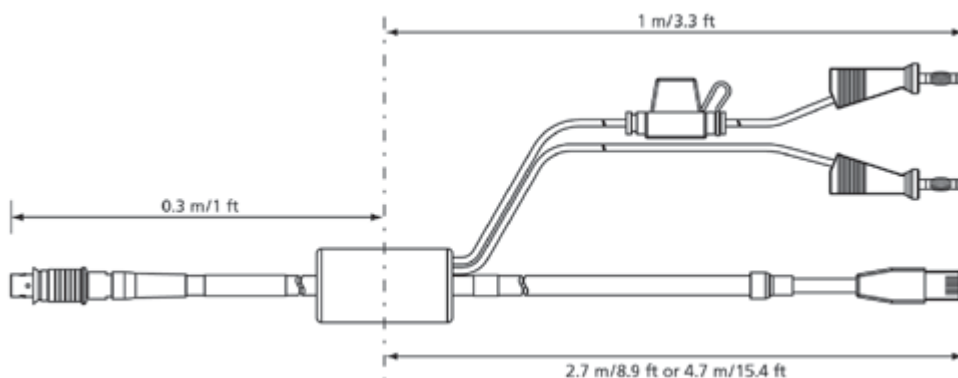

Ethernet-PC-Verbindungs- und Stromversorgungskabel, Lemo 1B FGL – RJ45 – Sicherheitsbananenstecker (8fc-8mc+2mc), 3 m

3.00 m	CBEP4105.1-3	F-00K-110-026
9.84 ft		

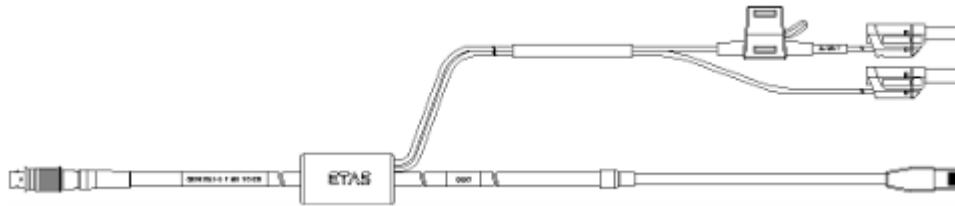

Ethernet-PC-Verbindungs- und Stromversorgungskabel, Stromspeisung in der Nähe des PCs, Lemo 1B FGL – RJ45 – Bananenstecker (8fc-8mc+2mc), 5 m

5.00 m	CBEP415.1-5	F-00K-105-680
16.40 ft		

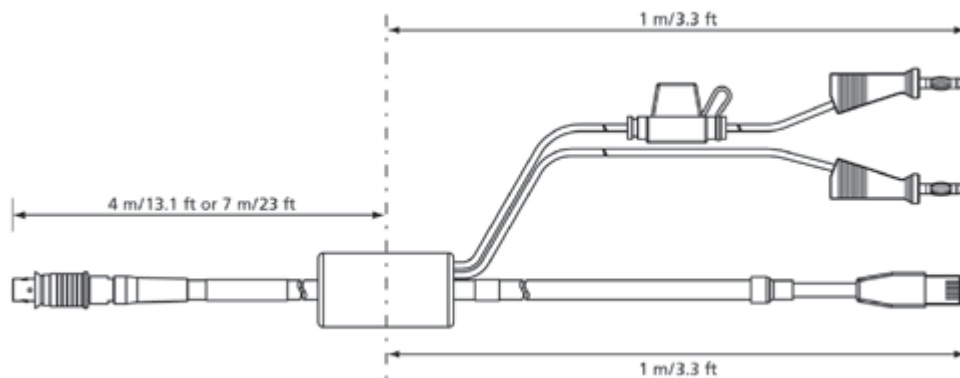

Ethernet-PC-Verbindungs- und Stromversorgungskabel, Stromspeisung in der Nähe des PCs, Lemo 1B FGL – RJ45 – Sicherheitsbananenstecker (8fc-8mc+2mc), 5 m

5.00 m	CBEP4155.1-5	F-00K-110-027
16.40 ft		

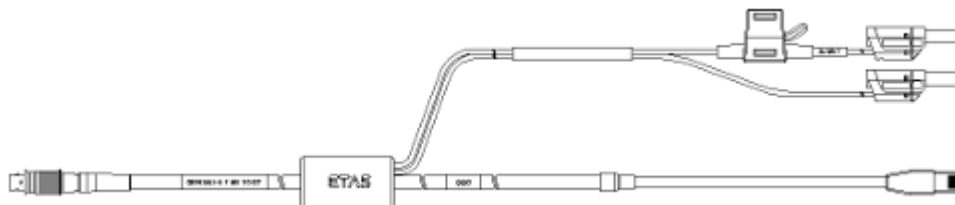

B – Stromversorgung und Verbindung zu ES592, ES593 oder ES595 Schnittstellenmodul / ES600 Netzwerkmodul [3,4,5,7]

Ethernet-Verbindungs- und Stromversorgungskabel, Lemo 1B FGF – Lemo 1B FGL – Bananenstecker (8mc-8fc+2mc), 3 m

3.00 m	CBEP420.1-3	F-00K-105-292
9.84 ft		

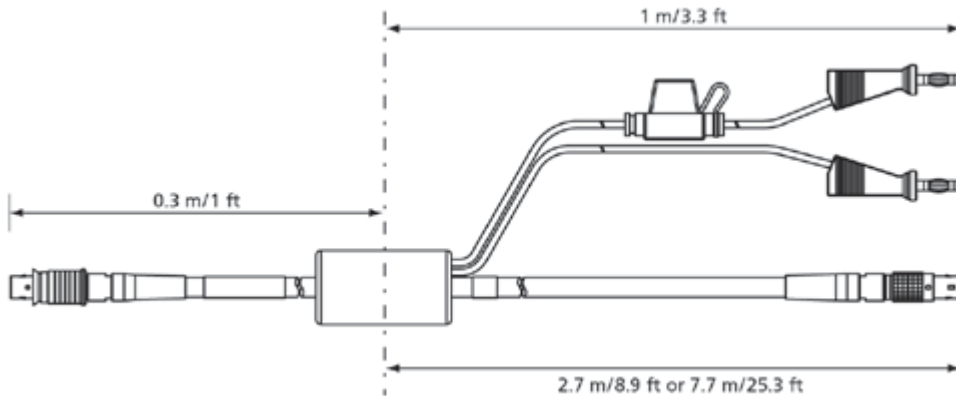

Ethernet-Verbindungs- und Stromversorgungskabel, Lemo 1B FGF – Lemo 1B FGL – Sicherheitsbananenstecker (8mc-8fc+2mc), 3 m

3.00 m	CBEP4205.1-3	F-00K-110-041
9.84 ft		

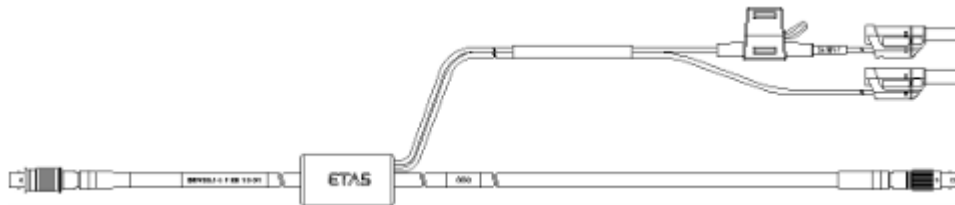

Ethernet-Verbindungs- und Stromversorgungskabel, Lemo 1B FGF – Lemo 1B FGL – Bananenstecker (8mc-8fc+2mc), 3 m

3.00 m	CBEP425.1-3	F-00K-105-972
9.84 ft		

Ethernet-Verbindungs- und Stromversorgungskabel, Lemo 1B FGF – Lemo 1B FGL – Sicherheitsbananenstecker (8mc-8fc+2mc), 3 m

3.00 m	CBEP4255.1-3	F-00K-110-029
9.84 ft		

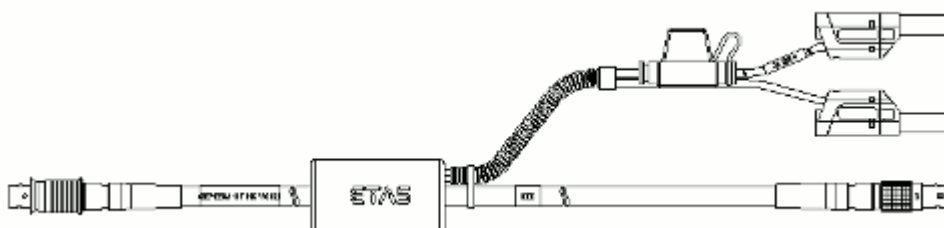

Verbindung mit ES400- und ES63x-Messmodulen und Stromversorgung [3,4,6,8]

Ethernet-Verbindungs- und Stromversorgungskabel für Modulketten, Lemo 1B FGL – Lemo 1B FGA – Bananenstecker (8fc-8mc+2mc)

0.50 m
1.64 ft CBEP4301-0m5 F-00K-104-928

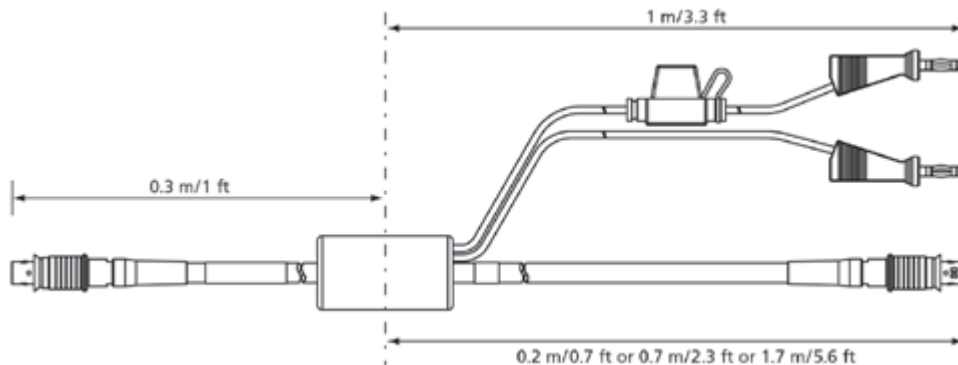

Ethernet-Verbindungs- und Stromversorgungskabel für Modulketten, Lemo 1B FGL – Lemo 1B FGA – Sicherheitsbananenstecker (8fc-8mc+2mc)

0.50 m
1.64 ft CBEP4305.1-0m5 F-00K-110-030

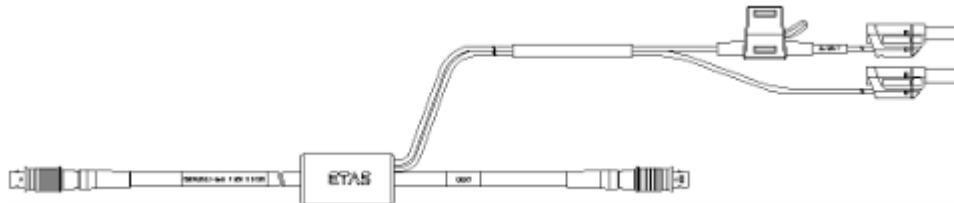

Verbindung mit ES600 Netzwerk-Modul [3,4,5]

Ethernet-PC-Verbindungskabel, Lemo 1B FGF – Lemo 1B FGL (8mc-8fc), 3 m

3.00 m
9.84 ft CBE400.2-3 F-00K-104-920



Ethernet-PC-Verbindungskabel, Hochflexibel, Lemo 1B FGF – Lemo 1B FGL (8mc-8fc), 0m5

0.50 m
1.64 ft CBE401.1-0m5 F-00K-106-128



Verbindung mit ES400 und ES63x Messmodulen [3,6]

Ethernet-Verbindungskabel für
Modulketten, Lemo 1B FGA – Lemo 1B
FGL (8mc-8fc), 0m45 0.45 m
1.48 ft CBE430.1-0m45 F-00K-104-923



Ethernet-Verbindungskabel für
Modulketten, Hochflexibel, Lemo 1B
FGA – Lemo 1B FGL (8mc-8fc), 0m14 0.14 m
0.46 ft CBE431.1-0m14 F-00K-105-676



Ethernet-Verbindungskabel für
Modulketten, Hochflexibel, Lemo 1B
FGA – Lemo 1B FGL (8mc-8fc), 0m3 0.30 m
0.98 ft CBE431.1-0m3 F-00K-105-685



Ethernet-Verlängerungskabel, Lemo
1B PHL – Lemo 1B FGL (8mc-8fc), 3 m 3.00 m
9.84 ft CBEX400.1-3 F-00K-105-294



SMB-Verbindung

SMB-Y-Verbindungskabel DSUB -
DSUB - DSUB (15fc-9mc-9mc), 0m3 0.30 m
0.98 ft CBAS100.1-0m3 F-00K-106-313

LSU 4.2 Lambda Oxygen Sensor und LSU 4.2 / LSU 4.7 Sensor Cables [9]

Bosch Lambdasonde LSU 4.2 für
Lambdameter (mit Universal-Stecker,
1 m lang) 1.00 m
3.28 ft LSUS_42 0-258-007-151

Lambdasondenkabel LSU 4.2 und LSU
4.7, Souriau 8ST12-35 - RB130fl -
Bananenstecker- BNC (22mc-
6fc+2mc+2mc), 3m 3.00 m
9.84 ft CBAL410.1-3 F-00K-106-302

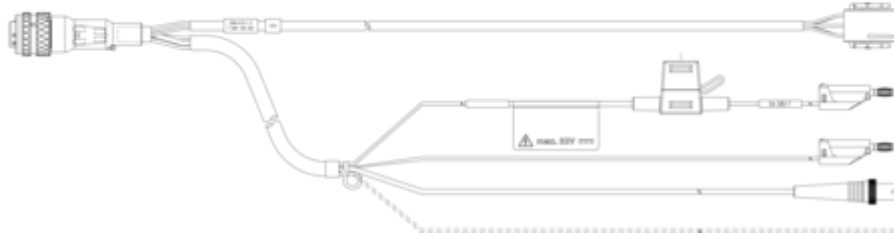

Lambdasondenkabel LSU 4.2 und LSU

4.7, Souriau 8ST12-35 - RB130ft -

3.00 m

CBAL4105.1-3

F-00K-110-033

Sicherheitsbananenstecker - BNC

9.84 ft

(22mc-6fc+2mc+2mc), 3m

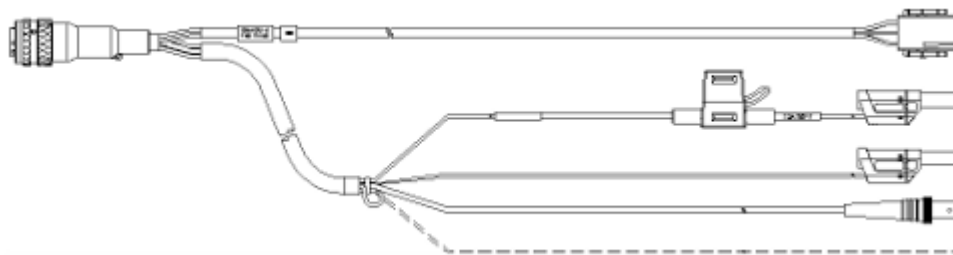

LSU 4.9 Lambda-Sauerstoff-Sonde und Sondenkabel [9]

Bosch Lambdasonde LSU 4.9, SR4,
RB150 Code1-Stecker, 300 Ohm, 1 m

1.00 m

LSUS_49

0-258-017-025

3.28 ft

Lambdasondenkabel LSU 4.9, Souriau

8ST12-35 - RB150 (Code 1) -

3.00 m

CBAL451.1-3

F-00K-105-926

Bananenstecker - BNC (22mc-

9.84 ft

6fc+2mc+2mc), 3 m

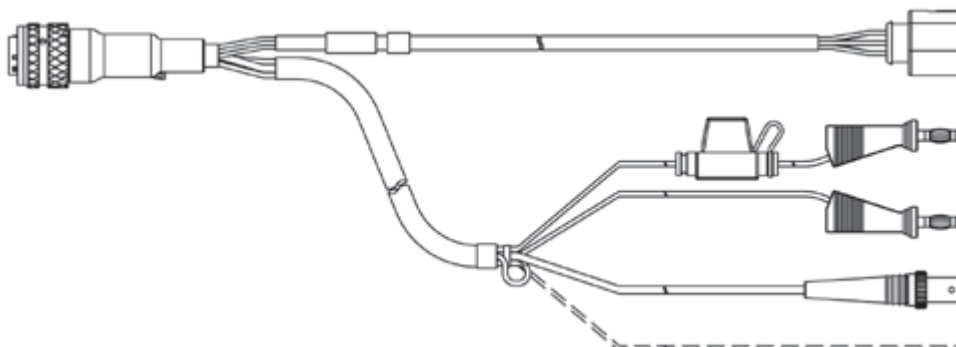

Lambdasondenkabel LSU 4.9, Souriau

8ST12-35 - RB150 (Code 1) -

3.00 m

CBAL4515.1-3

F-00K-110-038

Sicherheitsbananenstecker - BNC

9.84 ft

(22mc-6fc+2mc+2mc), 3 m

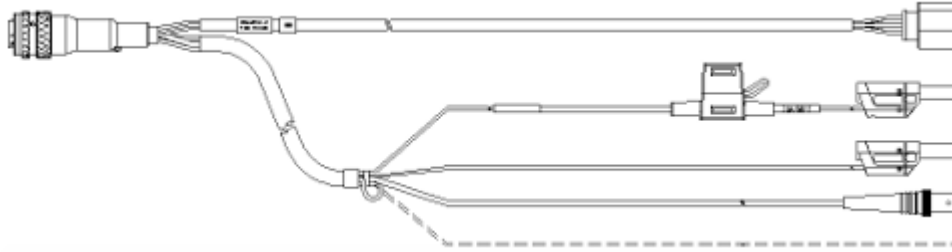

Lambdasondenkabel LSU 4.9, Souriau
 8ST12-35 - RB150 (Code 1) - 3.00 m
 Bananenstecker (22mc-6fc+2mc), 3 9.84 ft CBAL452.1-3 F-00K-106-127
 m

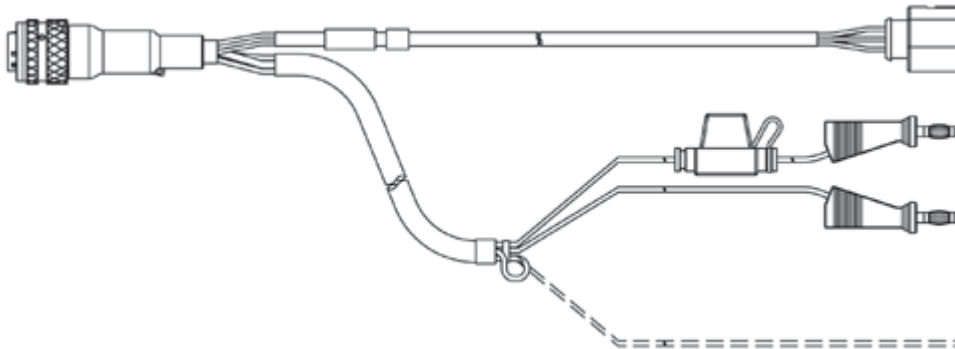

Lambdasondenkabel LSU 4.9, Souriau
 8ST12-35 - RB150 (Code 1) - 3.00 m
 Sicherheitsbananenstecker (22mc- 9.84 ft CBAL4525.1-3 F-00K-110-039
 6fc+2mc), 3 m

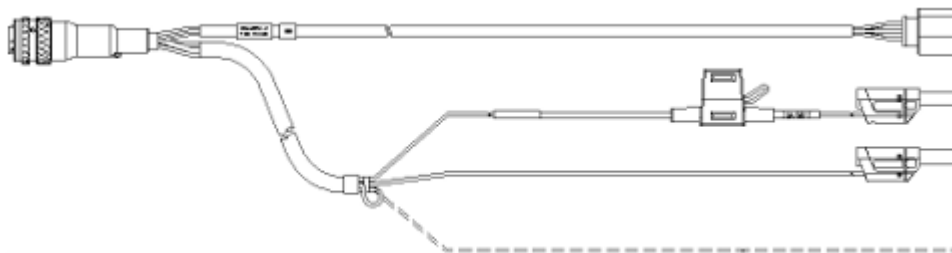

Lambdasondenkabel LSU 4.9, Souriau
 8ST12-35 - RB150 (Codierte A) - 5.00 m
 Bananenstecker- BNC (22mc- 16.40 ft AS_CBAL455.1-5 F-00K-106-308
 6fc+2mc+2mc), 5m / 16.4 ft

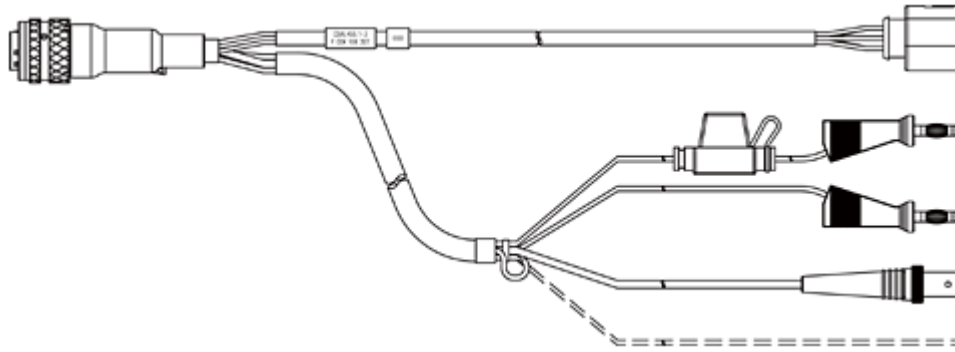

LSU ADV Lambdasonde und Sondenkabel [10]

Lambdasonde LSU ADV-G für Benzinmotoren, Schutzröhre TP3, Trapez-Stecker, Code A7, 300 Ohm, 1m / 3.3 ft	1.00 m 3.28 ft	LSU_ADV_G	F-00K-106-409
--	-------------------	-----------	---------------

Lambdasondenkabel LSU ADV, Souriau 8ST12-35 - Trapez-Stecker, Code A7 - Bananenstecker- BNC (22mc-7fc+2mc+2mc), 3m / 9.8 ft	3.00 m 9.84 ft	CBAL463.1-3	F-00K-106-310
--	-------------------	-------------	---------------

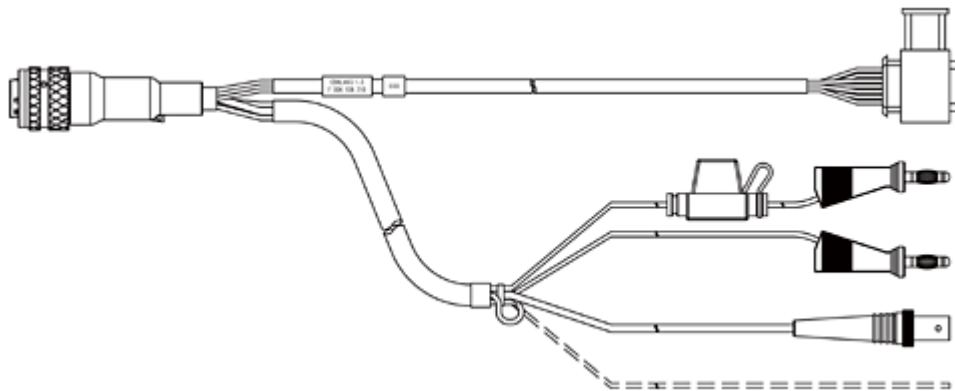

Lambdasondenkabel LSU ADV, Souriau 8ST12-35 - Trapez-Stecker, Code A7 - Sicherheitsbananenstecker - BNC (22mc-7fc+2mc+2mc), 3m / 9.8 ft	3.00 m 9.84 ft	CBAL4635.1-3	F-00K-110-035
---	-------------------	--------------	---------------

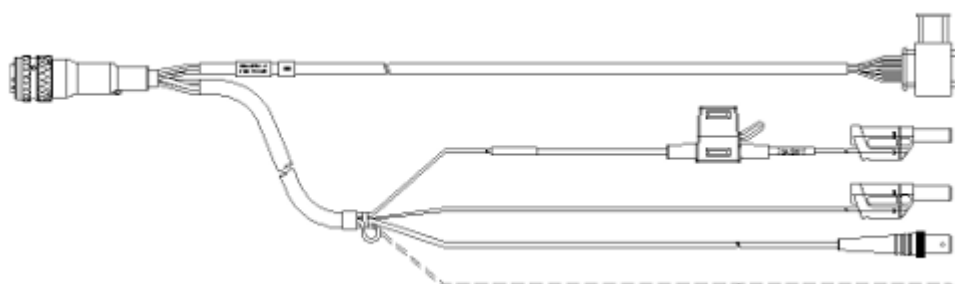

NTK ZFAS®-U2 - Lambdasondenkabel [11]

Lambdasondenkabel ZFAS®-U2,

Souriau 8ST12-35 – RB150 (Code 1) – 3.00 m
Bananenstecker (22mc-6fc+2mc), 3 9.84 ft CBAL472.1-3 F-00K-107-313
m / 9.8 ft

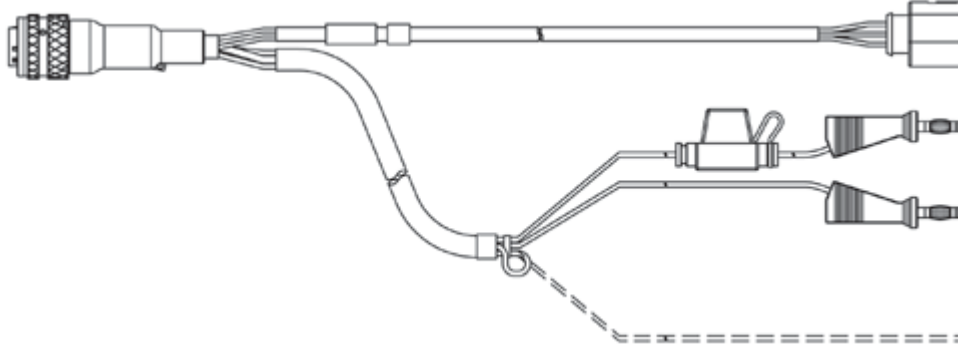

Lambdasondenkabel ZFAS®-U2,

Souriau 8ST12-35 – RB150 (Code 1) – 3.00 m
Sicherheitsbananenstecker (22mc- 9.84 ft CBAL4725.1-3 F-00K-110-040
6fc+2mc), 3 m / 9.8 ft

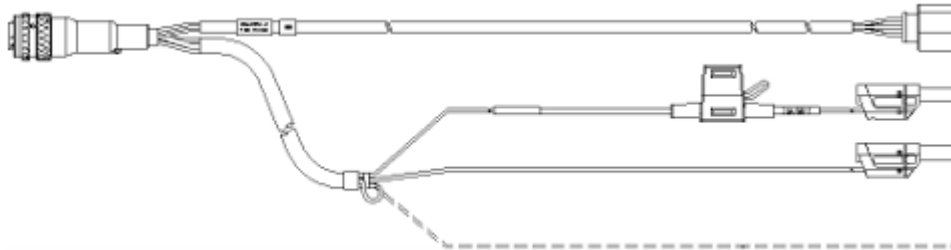

Externer Drucksensor und Erweiterungskabel (zusätzliches Zubehör für ES635/ES636)

Drucksensor PS63 F-00K-106-679

Erweiterungskabel für Drucksensor PS63 CBAX100.1-3 F-00K-106-680

Hinweise

- [1] Stromversorgungskabel oder Ethernetkabel sind nicht in Lieferung enthalten.
- [2] Temperaturbereich -40°C (-40°F) bis +70°C (158°F).
- [3] Temperaturbereich -40°C (-40°F) bis +125°C (257°F).
- [4] Inklusive Verpolschutz, Überlastschutz und Standardsicherung

- [5] Lemo-Anschluss in Richtung Messmodul-Kette, IP67 konform
- [6] Lemo-Anschluss auf beiden Seiten, IP67 konform
- [7] Nicht kompatibel mit ES600/ES610/ES611/ES620/ES650 (Stromversorgungskabel CBEP120 wird mit ES6xx benutzt).
- [8] Nicht kompatibel mit ES59x, ES6xx, ES11xx (Verbindungskabel CBE130 oder CBE140 werden mit diesen Einheiten benutzt).
- [9] TEDS zur Identifikation des Sondentyps befinden sich im Sondenkabel.
- [10] TEDS zur Identifikation des Sondentyps befinden sich in der Lambda-sonde.
- [11] NTK ZFAS®-U2-Lambdasonden werden nicht von ETAS vertrieben. Wenn Sie maßgeschneiderte Kabel benötigen, wenden Sie sich bitte an Ihren ETAS-Ansprechpartner oder an sales.de@etas.com.

