

# Fuel Cell Stack Power Prediction Model Using Gaussian Process Regression Model

Ryo KOBAYASHI<sup>1</sup> Koichiro FURUSAWA<sup>1</sup> Kensuke UMEZAWA<sup>1</sup>

## ABSTRACT

A fuel cell stack power prediction model that takes into consideration the various stack control parameters is important in the optimization design of the controls for each item of auxiliary equipment in a system equivalent to that of an actual vehicle. However, creating a model for quantitative prediction of stack power requires large amounts of data concerning the materials and structure inside the fuel cell. Moreover, since the internal phenomena are complex, large-scale modeling is necessary. For this research, a design of experiment method known as the space filling technique was used to acquire data efficiently. With the acquired data as a basis, the use of Gaussian process regression made it possible to create a model capable of predicting stack performance as well as the temperature and pressure in the various parts of the stack in a short computation time. It was also made clear that this model could be used to calculate operating conditions that would maximize stack power, and verification by testing showed that it would be possible to obtain a power prediction model that could be used to investigate stack performance from a limited amount of test data.

## 1. Introduction

### 1.1. Background

The polymer electrolyte fuel cell (FC) converts chemical energy directly into electrical energy using hydrogen (H<sub>2</sub>) as a fuel. This gives it higher energy efficiency than an internal combustion engine, while water is the only substance it emits during operation. It is, therefore, a power generating device with low environmental impact, and as such it is expected to have a wide range of uses, including in automobiles and trucks, as backup power sources for factories, and so on<sup>(1)</sup>. The automobile industry, in particular, is pursuing development of FC automobiles with low environmental impact as a way of achieving electrification according to the laws and regulations of different countries. However, the penetration rate of FC automobiles is low for various reasons, including inadequate infrastructure development and the high cost of FC stacks<sup>(2)</sup>. Realizing lower-cost FC stacks will require achieving the necessary power and durability with limited catalyst loading and active area<sup>(3)</sup>. The development of materials and optimization of control to enhance power output are therefore considered to be necessary.

Current distribution and electrochemical reaction activity inside the FC stack change according to the gas, temperature, and water produced by the generation of electricity in the electric power-generating environment.

Since the stack performance changes as a result, multiple studies are being conducted on the reproduction of the stack interior environment by mathematical modeling for the purpose of predicting stack performance with respect to control<sup>(4),(5)</sup>. When performing mathematical modeling of the FC stack, the various parameters influence each other, and the modeling becomes complicated as a result. This also requires understanding of the various theoretical formulas for the physical phenomena involved, the physical properties for the various materials, and so on<sup>(6)</sup>. Consequently, it becomes necessary to have accurate measurements and coefficient fitting in order to obtain multiple parameters every time a change is made to the materials or FC structure.

Regarding other modeling methods, with the development of artificial intelligence technology, increasing research is being done on modeling that uses machine learning<sup>(7)</sup>. The advantages of FC stack performance modeling by machine learning include, for example, the possibility of modeling the complex state of fluids and water inside the stack without performing a simulation.

Supervised learning is one type of machine learning. By appropriately labeling the input and output of feature values in measurement data, it learns the data and creates a model. Stack power prediction models that use artificial neural networks, which are one type of machine learning that is supervised learning, are highly accurate and capable

<sup>1</sup> Innovative Research Excellence Power Unit & Energy

E-mail: ryo\_01\_kobayashi@jp.honda

Table 1 Definition of input and output parameters

	Anode				Cathode			Coolant			Electrical
Input parameter	Flow rate (An_Q)	Relative humidity (An_RH)	Pressure (An_P)	N <sub>2</sub> concentration (An_N2)	Flow rate (Ca_Q)	Pressure (Ca_P)	Relative humidity (Ca_RH)	Flow rate (Co_Q)	Pressure (Co_P)	Temperature (Co_T)	Current density (CD)
Output parameter	Differential pressure (An_dp)				Differential pressure (Ca_dp)			Outlet pressure		Outlet temperature	Power

of quantitative prediction of performance<sup>(8), (9)</sup>. However, creating a performance prediction model that uses artificial neural networks requires large quantities of measurement data. Furthermore, the examples in the references<sup>(8), (9)</sup> all have about five explanatory variables, and since the distribution of explanatory variables is limited to about three levels for each variable, the possible range of accurate stack power prediction is also limited. For this research, therefore, measurement data was acquired efficiently by the design of experiment (DoE) method, and Gaussian process regression<sup>(10)</sup> was used to create from that data a predictive model for FC stack power, differential pressure, and outlet temperature with respect to 11 variables that serve as input control parameters. In order to enhance the output of the created stack power prediction model, overall optimization of the control parameter variables was carried out and the enhancement of stack power was verified using an actual FC stack. This made clear that a stack power prediction model using Gaussian process regression with a small quantity of training data can be used to investigate control for the purpose of enhancing output.

## 1.2. Overview of Stack Modeling

Figure 1 shows an overview of the stack that was evaluated in the course of creating a Gaussian process regression model for this research.

First, the space filling technique<sup>(11)</sup>, which is a DoE, was used to set the experiment conditions so that training data can be acquired efficiently for use in machine learning. A

device was also created with the capability to perform the experiment fully automatically as well as to preprocess the data. This is done simply by installing the FC stack on the device, and it creates the experiment conditions, performs the experiment, acquires the experiment data, and organizes the data. The experiment data acquired by the fully automated evaluation system was used to create the machine learning statistical model of the FC stack by Gaussian process regression. The input and output for the created model are shown in Table 1. The ETAS ASCMO tool from ETAS was used to formulate the experiment design and to create the Gaussian process regression model.

## 2. Stack Performance Evaluation

### 2.1. Setting the Experiment Conditions

When using DoE to set the experiment conditions, it is necessary to set the upper limits and the lower limits for each of the 11 control parameters. The upper and lower limits were set according to two perspectives, that of the range within which the stack components will not be damaged, and that of the upper and lower limits for control of the evaluation device. As one example, in cases when differential pressure is generated inside the stack between the anode and cathode, then from the perspective of stack protection, an upper limit was set for the differential pressure between the anode and cathode in order to protect components from differential pressure at or above a certain level<sup>(12)</sup>.

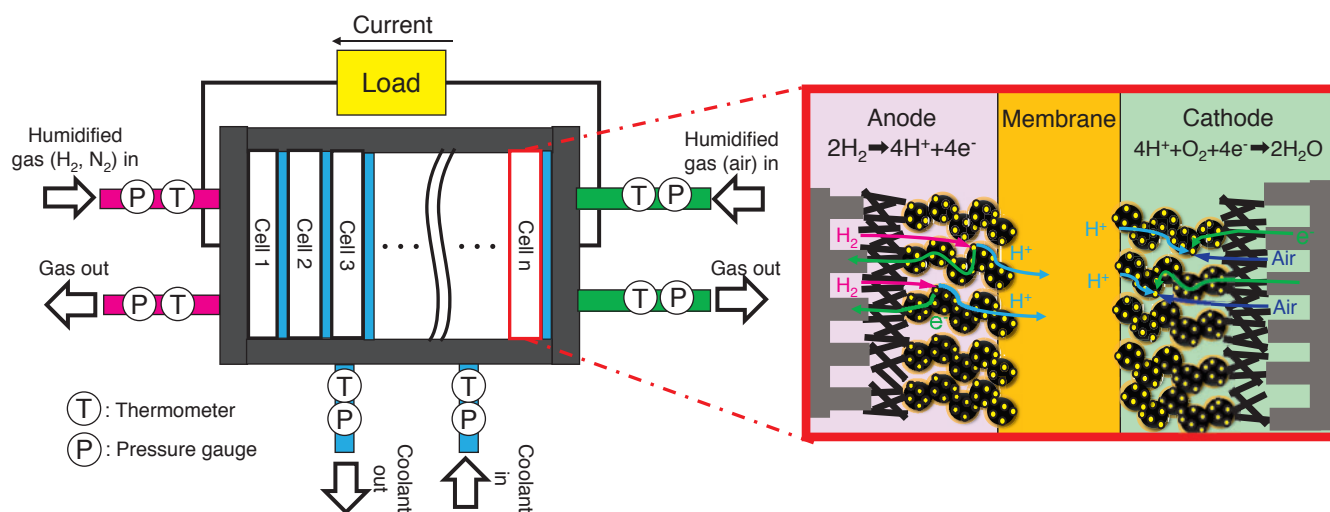

Fig. 1 Schematic image of stack

2.2. Experiment Procedure

A stack of nine cells in layers was fabricated to conduct the experiment. The experiment procedure was set as shown in Fig. 2 for conducting the evaluation under each of the measurement conditions based on DoE.

The anode and cathode were supplied with H<sub>2</sub> and nitrogen (N<sub>2</sub>) and the temperatures of the stack and humidifier were adjusted. Next, air was introduced to the cathode and the backpressure of the anode and cathode was adjusted. If the open circuit voltage of the stack is held to the vicinity of 1 V at this time, the components will be progressively degraded. The current value was therefore set so that the voltage would be decreased slightly.

Generation would proceed at 1 A/sec until the current reached the set value. That current would be maintained for 30 minutes, and the average value for the last minute would be taken as the stack power performance under the target measurement conditions. After measurement, N<sub>2</sub> would again be introduced to the cathode, the stack voltage would be lowered, and discharged water would be treated under temperature adjustment and H<sub>2</sub> and N<sub>2</sub> supply conditions.

2.3. Fully Automated Evaluation System

A system capable of automated evaluation was created in order to conduct the experiment under the above conditions and procedure and to organize the data for use in creating the Gaussian process regression model. An overview is shown in Fig. 3.

The fully automated evaluation system is made up of three main parts, which are the experiment control system, the experiment device system, and the data analysis part. In the experiment control system, a device control file is created using 11 variables based on the DoE created using the ETAS ASCMO software made by ETAS, and a control profile converted for use in experiment device control is transmitted. In the experiment device system, control of the above-mentioned experiment procedure is implemented based on the control profile in which only the control parameter portion related to the 11 variables is different. The experiment data under each condition is measured by each of the measuring instruments and recorded by the logger. The measurement data is organized automatically in the data analysis part and then labeled according to Table 1

to process it into data for machine learning use. A Gaussian process regression model is then created using that created data set. ETAS INCA-FLOW software from ETAS was used as the management system to operate this device in a fully automated manner.

2.4. Gaussian Process Regression Model of the Stack

Gaussian process regression was used for modeling the stack. A feature of Gaussian process regression is that it is nonlinear and uses probability theory so that model predicted values have uncertainty and the probability of predicted values can be distinguished<sup>(10)</sup>.

The prediction equation based on Gaussian process regression used in modeling is shown in Eq. (1)<sup>(13)</sup>.

$$y(\vec{x}) = \sum_{i=1}^N C_i \cdot e^{-\frac{2}{1} \sum_{l=1}^D \frac{(x_{i,l} - x_l)^2}{r_l^2}} \tag{1}$$

For the Gaussian kernel function in the exponential function part, the generally used ARD squared exponential kernel was used.  $\vec{x}$  is the input vector of the explanatory variable,  $N$  is the number of training data items, and  $C_i$  is the coefficient of the  $i$ th training data item, derived from

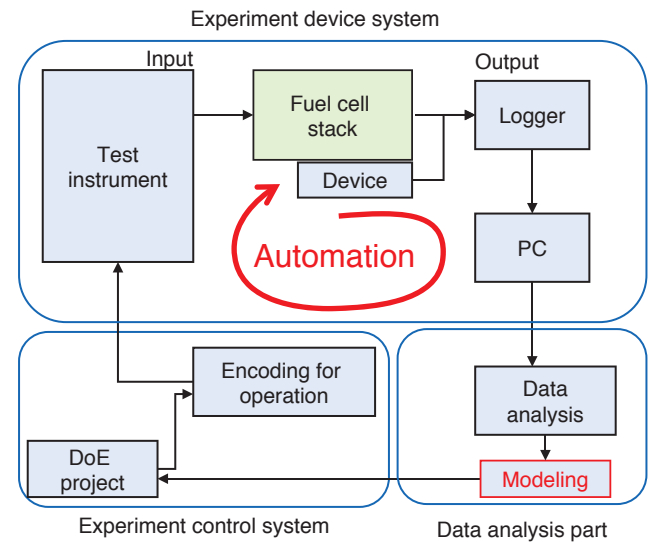

Fig. 3 Schematic image of automated test process

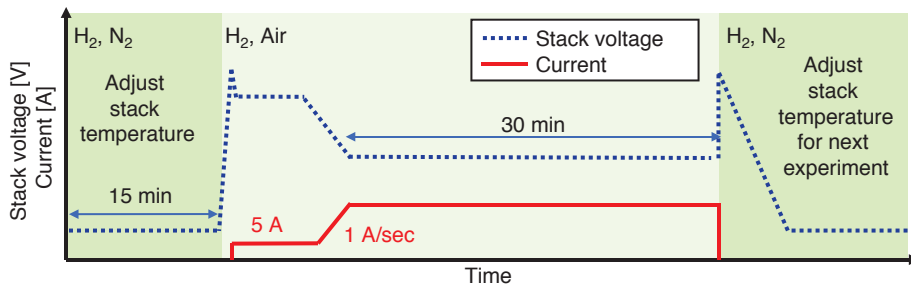

Fig. 2 Schematic image of experiment protocol

the hyperparameters.  $D$  is the number of dimensions,  $X_{i,l}$  indicate the training data location,  $X_l$  is the input value, and  $r_l$  is the length scale. Of these,  $C_i$  and  $r_l$  are hyperparameters, and in ASCMO, these hyperparameters are determined by marginal likelihood optimization algorithms<sup>(14)</sup>.

Out of the experiment conditions set by the space filling technique, the Gaussian process regression model was created on the basis of the data set consisting of 169 conditions acquired by the fully automated evaluation system. Table 1 shows the definitions (labeling) of the parameters for modeling. The  $N_2$  concentration here is the proportion of  $N_2$  in the gas supplied to the anode inlet. The differential pressures of the anode and cathode are the difference in pressure at the stack inlet and outlet. In modeling the power, the stack output was converted from the total for nine cells to the equivalent for one cell. For the 11 defined input parameters, each output item was modeled by Gaussian process regression.

The accuracy of the created model was evaluated using the leave-one-out (LOO) method<sup>(15)</sup>. Model accuracy obtained by the LOO method can be evaluated by the determination coefficient  $R^2$ . If  $R^2$  is 0.9 or greater, it can be determined that a model capable of quantitative prediction has been obtained, and if  $R^2$  is 0.6 or greater, it can be determined that a model capable of qualitative prediction has been obtained<sup>(15)</sup>.

### 3. Results and Discussion

#### 3.1. Stack Model Evaluation

The anode differential pressure, cathode differential pressure, coolant outlet pressure, coolant outlet temperature, and stack power were modeled on the basis of the input conditions defined in Table 1. Figure 4 shows the results for evaluation of the created model by the LOO method. The modeling used 169 items of measurement data. An accuracy of  $R^2 > 0.9$  is indicated for the prediction of stack power and the various outlet parameters. This indicates that a model has been obtained that is capable of quantitative

prediction of stack power in a steady state as well as cathode differential pressure, anode differential pressure, and coolant outlet temperature and pressure.

The contributions to stack power made by the 11 variables were evaluated based on the Gaussian process regression model. The parameter making the greatest contribution to power is current, and when that contribution is taken as 1, the relative contributions of the other parameters are shown in Fig. 5. It is apparent that the contribution of the anode control parameter is low and the contribution of the cathode control parameter is high. Since the FC overvoltage is more dependent on the oxygen reduction reaction in the cathode than on the hydrogen oxidation reaction in the anode<sup>(16)</sup>, it is apparent that the stack characteristics for the power prediction model in this research have also been selected appropriately.

Figure 6 shows the polarization curve for the stack measured under the various standard conditions and the average power values predicted by the power prediction

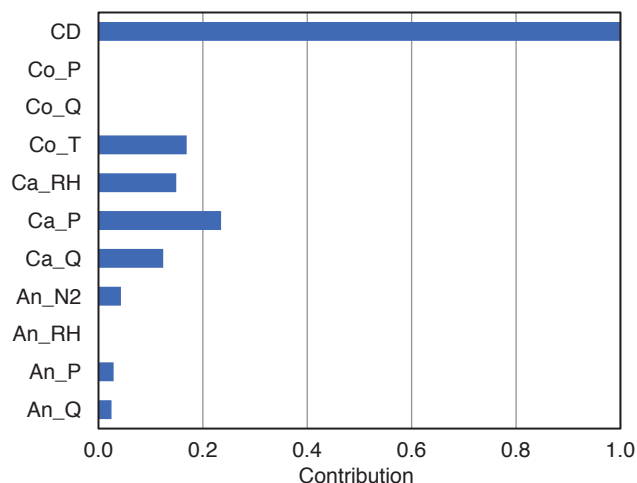

Fig. 5 Input relevance to stack power

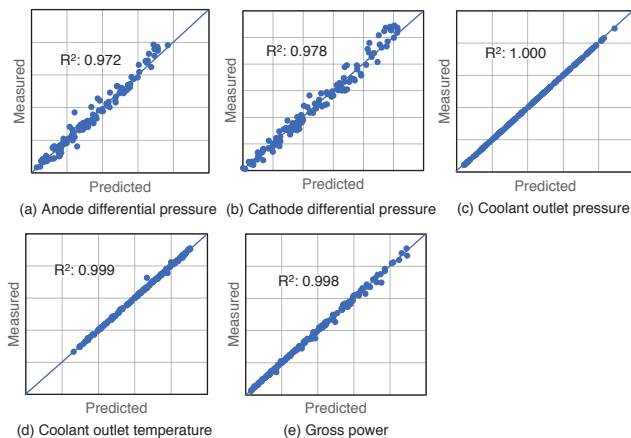

Fig. 4 Results of leave one out evaluation

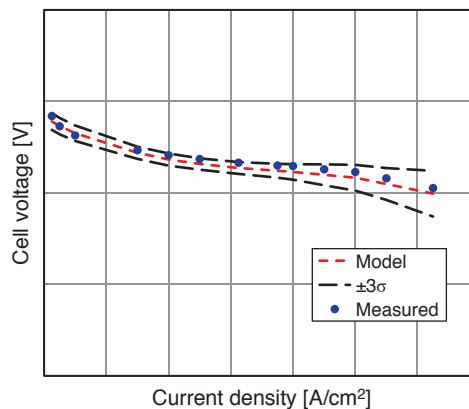

Fig. 6 Comparison of model prediction and measured data

model when the control parameters under the various standard conditions have been input. The model created by Gaussian process regression yields the predicted value averages and standard deviation  $\sigma^{(10), (17)}$ . Figure 6 also shows the results for model prediction average values within  $\pm 3\sigma$ . The polarization curve from actual measurement of the stack falls within the  $\pm 3\sigma$  range, indicating that output under the various operating conditions can be predicted.

In Fig. 6, the  $\sigma$  spread is greater at high current density than at low current density. This is because the number of measurement data items on the high load side is approximately 12% of the total number of measurement data items and there is less learning data than for low loads.

Up to now, stack power had been predicted by the results of parametric study of experiment designs created using multiway layout<sup>(18)</sup>. Consequently, there was an issue in that the number of measurement points increased conspicuously when multiple variables changed simultaneously. Furthermore, in order to evaluate 11 variables in a multiway layout and create a highly accurate prediction model, it is necessary to conduct tens of thousands of experiments. The experiment design for this research used the space filling technique, which is a DoE method, to perform modeling by Gaussian process regression. This made clear that prediction of the various output items was possible with the number of evaluation points reduced to several hundred and while the 11 correlated variables underwent simultaneous change.

### 3.2. Output Enhancement by Examination of Control Parameters Using a Power Prediction Model

Verification was performed regarding whether or not it is possible to investigate the various control parameters using the stack power prediction model and enhance output. Verification involved overall optimization of the control parameters with the aim of maximizing both the low current density and high current density output of the stack.

Figure 7 shows average values for model prediction output and measured output under standard conditions and optimized conditions. The specifications of the measured stack were the same as those of the stack used in creating the model, but a different stack was used.

The average power prediction values calculated from the power prediction model can be expected to show power enhancement of 8.9% for low current density and 7.0% for high current density when the control parameters are changed from the standard conditions. As measured, the figures were 4.1% and 6.0%. Therefore it is possible to use the power prediction model created for this research to investigate the enhancement of stack power.

Figure 8 shows the ratio of the control parameters for both low current density and high current density as optimized overall to those parameters under standard operating conditions. Under the optimized conditions, the cathode pressure and cathode flow rate are set to higher levels than under the standard operating conditions, and the

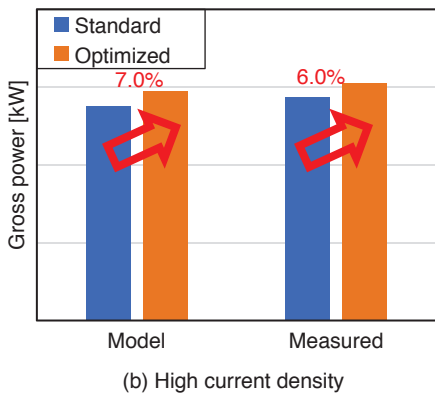
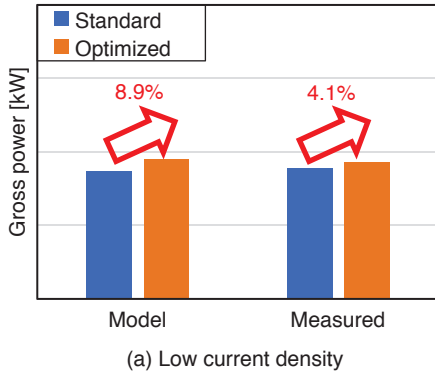

Fig. 7 Effect of optimized parameters on stack power

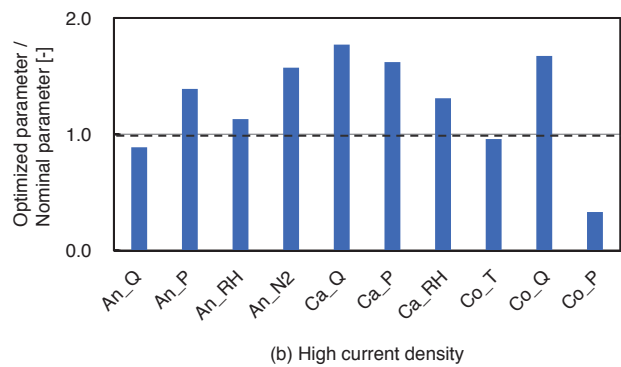
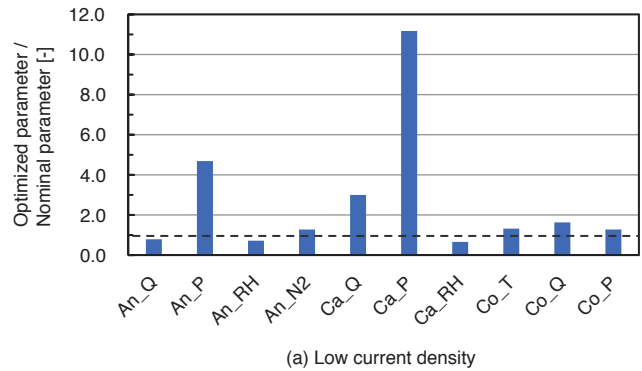

Fig. 8 Ratio of optimized parameter / nominal parameter

enhancement of power can be considered to occur because the cathode overvoltage is reduced. In the anode, on the other hand, the conditions call for flow to be reduced and  $N_2$  concentration to be increased, and this can be considered to be because anode overvoltage makes almost no contribution to power performance. These adjustments of the control parameters are also supported by the results in Fig. 5 and by general FC characteristics<sup>(16)</sup>. Creating a more accurate power prediction model appears likely to necessitate increased density of data overall in the space formed from 11 dimensions.

The stack power prediction model created in this research will be used going forward to proceed with optimization of an FC system equivalent to that of an actual vehicle that also combines accessories and related items.

#### 4. Conclusion

The results obtained in this research are shown as follows.

- (1) With the number of stack performance evaluation points reduced to the smallest amount by means of the space filling technique, the various output items were modeled using Gaussian process regression on the basis of measurement data acquired by an automated system for experimentation and data analysis.
- (2) Using the Gaussian process regression model, the control parameters were optimized for the purpose of maximizing stack power, and this made it possible to investigate the enhancement of stack power.

Going forward, the model described in this paper will be used to carry out optimization at the system level.

#### References

- (1) [https://www.meti.go.jp/committee/kenkyukai/energy/suiso\\_nenryodenchi/pdf/001\\_04\\_00.pdf](https://www.meti.go.jp/committee/kenkyukai/energy/suiso_nenryodenchi/pdf/001_04_00.pdf)
- (2) <https://fccj.jp/pdf/2020-PEFC-1.pdf>
- (3) <https://www.nedo.go.jp/content/100871976.pdf>
- (4) Wu, H.-W.: A review of recent development: Transport and performance modeling of PEM fuel cells, *Applied Energy*, Vol. 165, p. 81-106, (2016)
- (5) Siegel, C.: Review of computational heat and mass transfer modeling in polymer-electrolyte-membrane (PEM) fuel cells, *Energy*, Vol. 33, Issue 9, p. 1331-1352, (2008)
- (6) Salva, J. A., Iranzo, A., Rosa, F., Tapia, E.: Validation of cell voltage and water content in a PEM (polymer electrolyte membrane) fuel cell model using neutron imaging for different operating conditions, *Energy*, Vol. 101, p. 100-112, (2016)
- (7) Wang, Y., Seo, B., Wang, B., Zamel, N., Jiao, K., Adroher, X. C.: Fundamentals, materials, and machine learning of polymer electrolyte membrane fuel cell technology, *Energy and AI*, Vol. 1, 100014, (2020)
- (8) Nanadegani, F. S., Lay, E. N., Iranzo, A., Salva, J. A., Sunden, B.: On neural network modeling to maximize the power output of PEMFCs, *Electrochimica Acta*, Vol. 348, p. 136345, (2020)
- (9) Han, I.-S., Chung, C.-B.: Performance prediction and analysis of a PEM fuel cell operating on pure oxygen using data-driven models: A comparison of artificial neural network and support vector machine, *Int. J. Hydrogen Energy*, Vol. 41, Issue 24, p. 10202-10211, (2016)
- (10) Rasmussen, C. E.: Gaussian Processes in Machine Learning, *Advanced Lectures on Machine Learning*, p. 63-71, (2003)
- (11) Santiago, J., Claeys-Bruno, M., Sergent, M.: Construction of space-filling designs using WSP algorithm for high dimensional spaces, *Chemometrics and Intelligent Laboratory Systems*, Vol. 113, p. 26-31, (2012)
- (12) Ebadighajari, A., DeVaal, J., Golnaraghi, F.: Optimal control of fuel overpressure in a polymer electrolyte membrane fuel cell with hydrogen transfer leak during load change, *Journal of Power Sources*, Vol. 340, p. 247-257, (2017)
- (13) Kruse, T., Ulmer, H., Kreuzinger, T., Lang, T.: Control Unit Calibration via HIL System and Measurement Data Based Model, *Journal of The Society of Instrument and Control Engineers*, Vol. 53, Issue 8, p. 752-757, (2014) (in Japanese)
- (14) Esteves, A., Kawamoto, A. M., Pelisser, A., Carmelutti, D.: Automated in-vehicle engine calibration to optimize emissions levels using machine learning, *SIMEA 2021*, (2021)
- (15) [https://www.etas.com/download-center-files/products\\_ASCMO/etas-ascmo-static-v5.9-user-guide-r01-en-202205.pdf](https://www.etas.com/download-center-files/products_ASCMO/etas-ascmo-static-v5.9-user-guide-r01-en-202205.pdf)
- (16) [https://www.jstage.jst.go.jp/article/ieejpes1990/120/6/120\\_6\\_885/\\_pdf](https://www.jstage.jst.go.jp/article/ieejpes1990/120/6/120_6_885/_pdf)
- (17) Rasmussen, C. E., Williams, C. K. I.: Gaussian Processes for Machine Learning, The MIT Press, (2005)
- (18) Morita, H.: Yokuwaku saishin jikken keikakuho no kihon to shikumi, *Shuwa System*, 281 p., (2019) (in Japanese)

#### ■ Author ■



Ryo KOBAYASHI



Koichiro FURUSAWA



Kensuke UMEZAWA