

INCA V7.4 – What's New

Changes / Extensions done in this Version

Overview

- 1. Product information (Use cases, Sample applications, Customer value)**
 - Performance
 - Functionality
 - Standards
 - Usability
 - HW support
 - Add-ons
- 2. INCA Product Family**
- 3. Phase out information**
- 4. General Notes**

Overview

1. **Product information (Use cases, Sample applications, Customer value)**
 - **Performance**
 - Functionality
 - Standards
 - Usability
 - HW support
 - Add-ons
2. **INCA Product Family**
3. **Phase out information**
4. **General Notes**

Performance

Parallel Hardware Initialization of Devices

ECU initialization in parallel

Speeds up initialization

- Setup target
- Checksum calculation
- Download

New UI concept

- Activities of all ECU are displayed in one common progress dialog

User option for switching between

- Sequential initialization
- Parallel initialization

Sequential Initializing

One progress dialog for **each** device

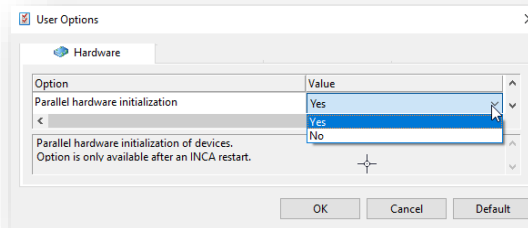
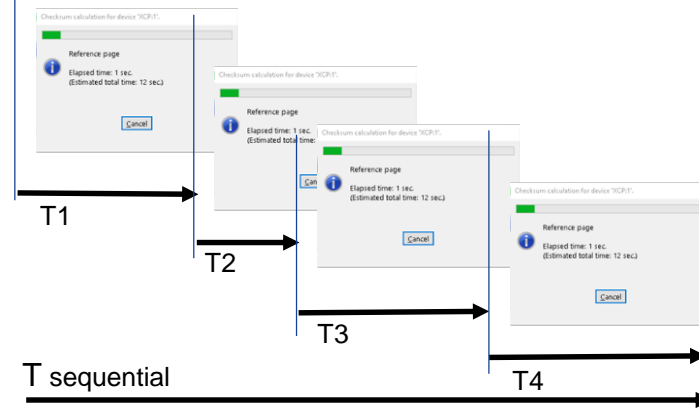

Parallel Initializing

One progress dialog for **all** devices

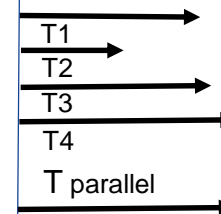
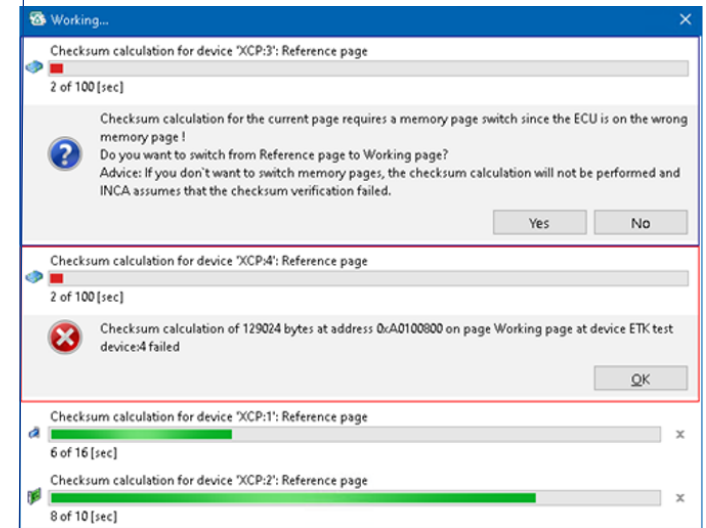

Available with INCA V7.4 SP2

Overview

1. **Product information (Use cases, Sample applications, Customer value)**
 - Performance
 - **Functionality**
 - Standards
 - Usability
 - HW support
 - Add-ons
2. **INCA Product Family**
3. **Phase out information**
4. **General Notes**

Functionality

EE – Battery cell imbalance evaluation table instrument

Easy detection of

- Range of voltage in cells
- Imbalance of cells

Sorting possible by

- Cell names
- Voltage
- Imbalance

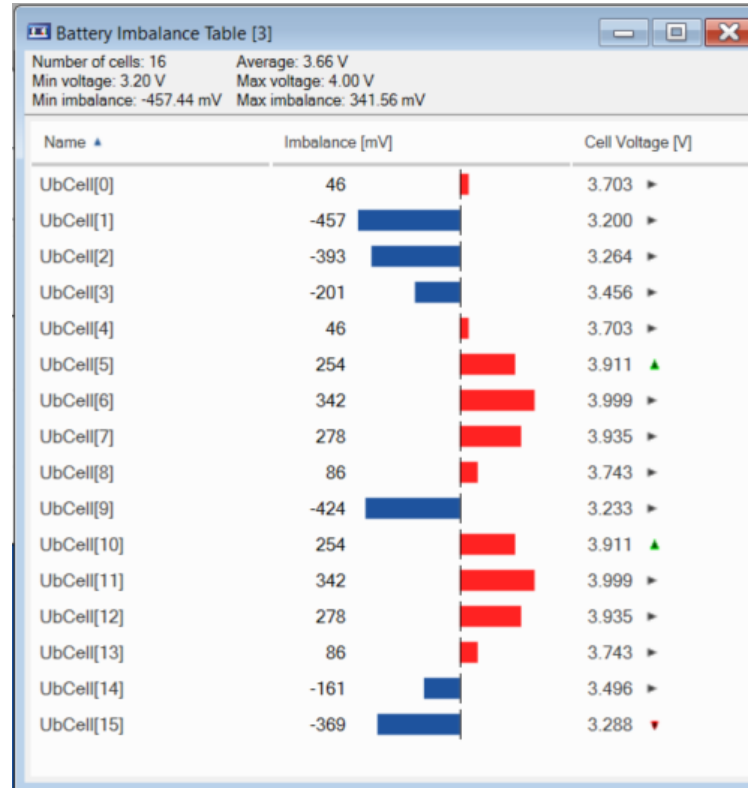

Functionality

EE – Battery cell imbalance graph evaluation table instrument

Easy overview of

- Range of voltage or temperatures in cells
- Imbalance of cells

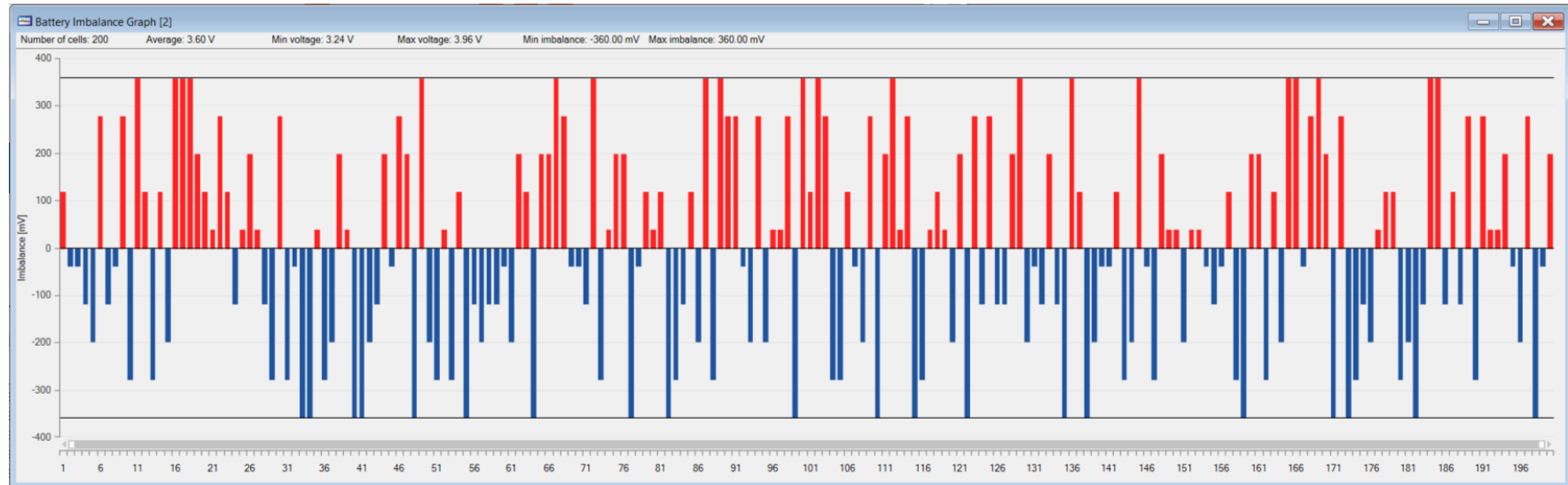

Available with INCA V7.4 SP7

Functionality

MACsec support for SOME/IP and Ethernet Monitoring

Ethernet Frame with VLAN

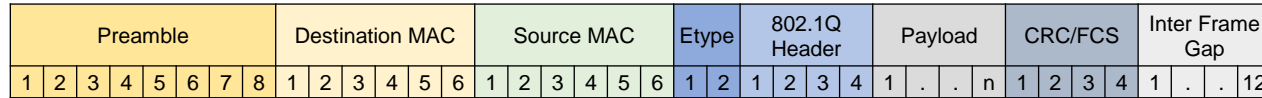

Ethernet Frame with VLAN + MACsec

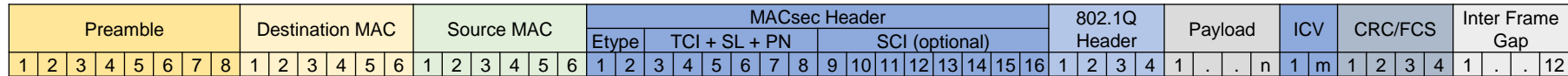

- The larger size of the header is detected by the Ethertype 0x88E5
- All other parts of the header are ignored
- Unencrypted payload can be measured by INCA
- Supported by local capturing and Vector devices

Functionality

Optimized Initialization of Devices connected to INCA

- Allow the initialization of a single device
- Allow the initialization of only those devices not yet in the *connected* state
 - i. New Menus in Hardware Configuration Editor

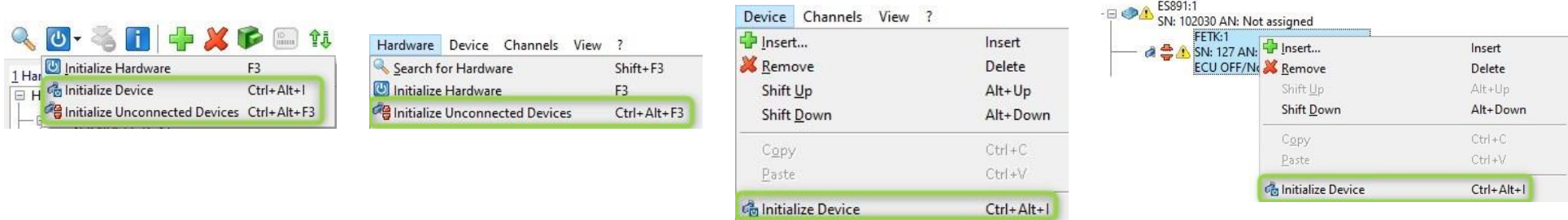

ii. New Menus in Experiment Environment

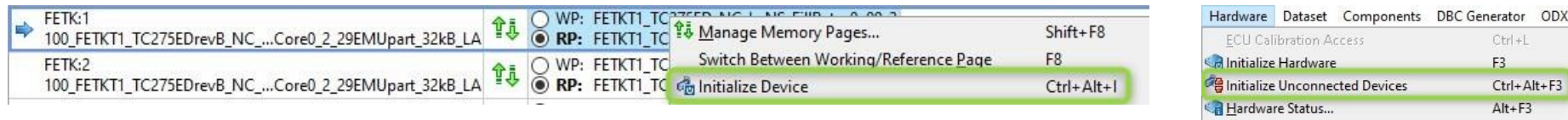

Functionality

VLAN – Local-NIC Support in INCA (XCP on UDP)

INCA offers now the functionality to communicate OS independent over a dedicated Network Interface Card with XCP on Ethernet.

The OS independent IP stack allows INCA to support VLAN tagged communication. IPv4 and IPv6 communication is possible independent of the IP setting of the used Network Interface Card.

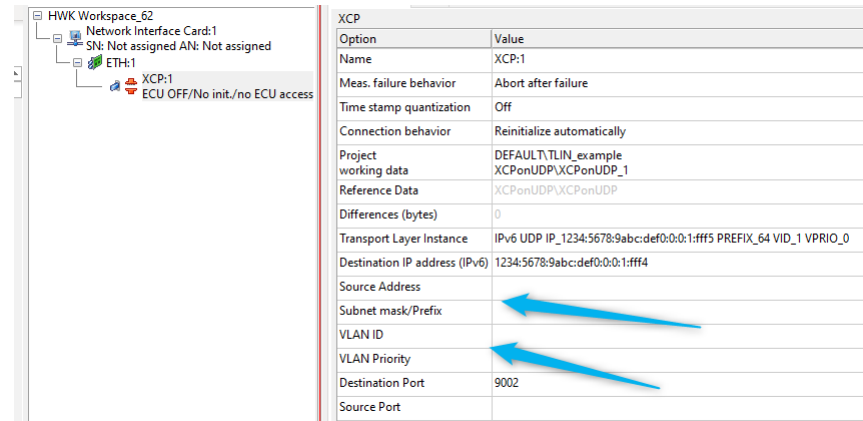
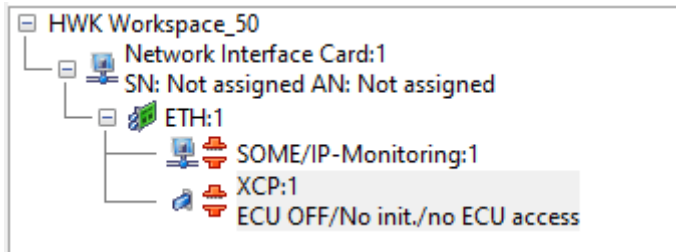

Functionality

Flexray – Enhanced FLX Start Up Node Configuration

Sometimes the Autosar files are containing only a subset of entire Flexray bus information, especially the ECU extract files are typically limited to a single ECU. But to start up the Flexray bus at least two startup controller are required.

INCA now offers all controller with startup capabilities and all other possible SLOT-IDs as input for the startup configuration.

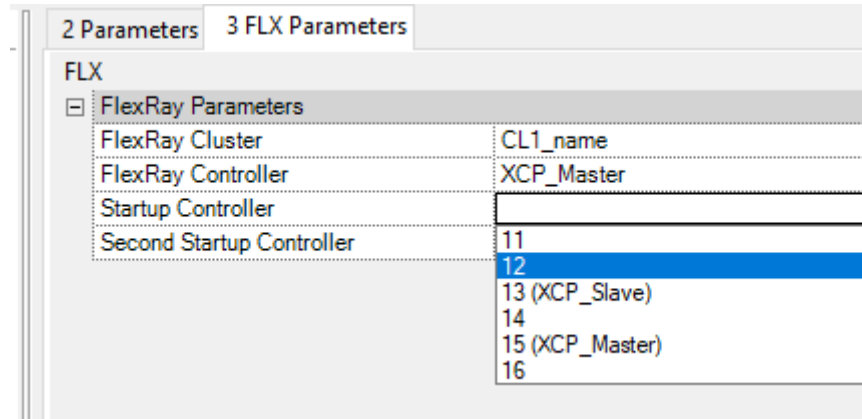

Functionality

ProF – Support functional addressing for UDS on CAN/CAN-FD

Some flash sequences require to send a UDS message on a functional CAN-ID to address multiple ECUs, e.g. to clear DTCs or to disable normal message transmission during flashing.

ProF now supports sending UDS messages on functional CAN-IDs and collecting the segmented or unsegmented response of a single ECU so that the response can be evaluated in the ProF script.

New command for functional requests:

```
DWORD UDS_PASS_THROUGH_FUNCTIONAL ( DWORD index,  
                                     LPCTSTR byteString,  
                                     DWORD noResponse  
                                     )
```

[in] **index** index of **FUNCTIONAL_CAN_ID** in CNF file

[in] **byteString** String with data bytes of UDS message

[in] **noResponse** Flag to signal if a response is expected:

- 0: wait for response until timeout has expired
- 1: no response expected

Functionality

XCP on ETH - Flat List of all Transport Layers

- One list of transport layers for all Ethernet Transport Layers
- (TCP) or (UDP) as prefix to determine the type
- For API usage the plain name is required without prefix

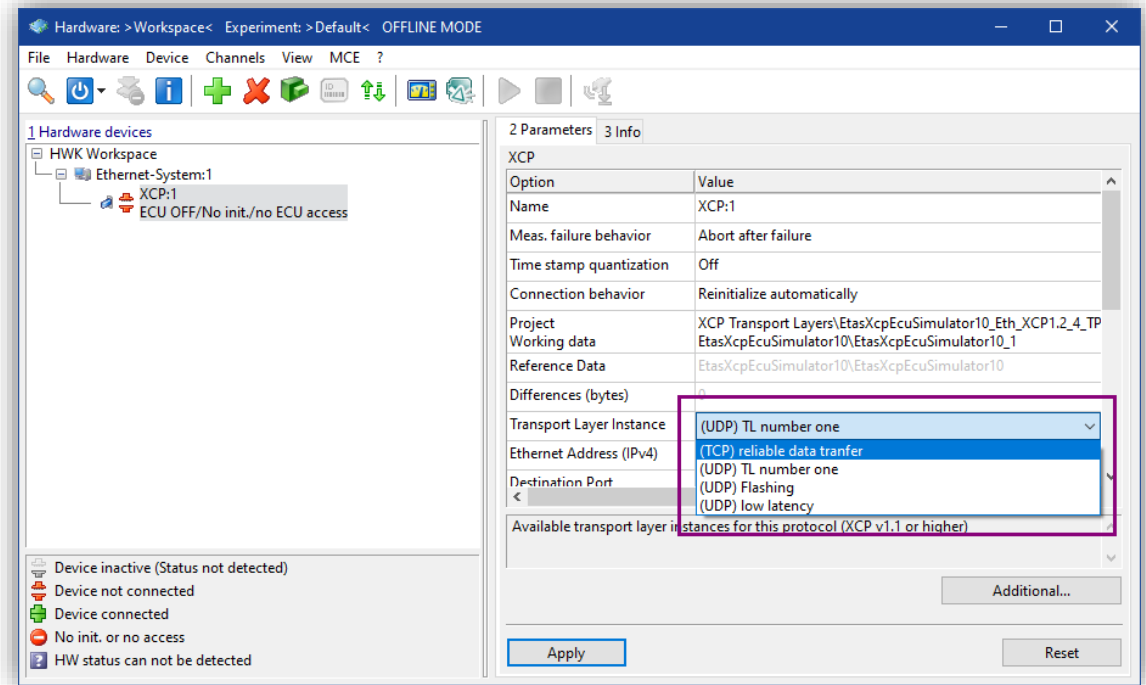
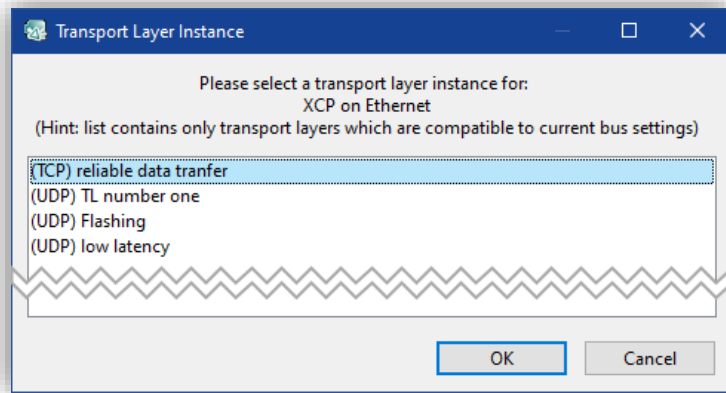

Functionality

XCP on CAN + XCP on ETH – Busload Calculation for STATIC DAQ



As already known from DYNAMIC DAQ, INCA supports now the bus load calculation also for STATIC DAQ.

This new feature is available for transport layers of type:

- XCP_ON_CAN
- XCP_ON_UDP
- XCP_ON_TCP

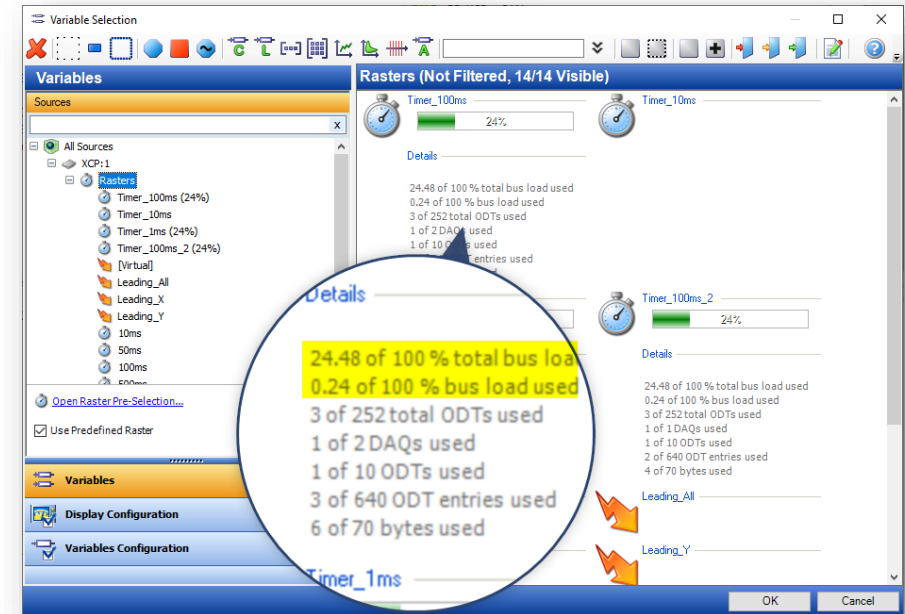

Available with INCA V7.4 SP5

INCA V7.4 – What's New

Functionality

XCP VLAN, IPv4/IPv6 Tagged Communication via ES886.2 (XCP on UDP)

- Four new parameters are available for XCP to configure the IP communication independent from the PC settings.
- ES886.2 supports VLAN tagged IPv4 and IPv6 communication.
- Untagged IPv4 and IPv6 communication will be supported with INCA V7.4.1.
- With this feature the PC doesn't need any IPv6 address or VLAN settings to communicate with an ECU in the vehicle network anymore.

Option	Value
Name	XCP:1
Meas. failure behavior	Abort after failure
Time stamp quantization	Off
Connection behavior	Reinitialize automatically
Project working data	
Reference Data	
Differences (bytes)	
Destination IP address (IPv4)	
Source Address	
Subnet mask/Prefix	
VLAN ID	
VLAN Priority	
Destination Port	

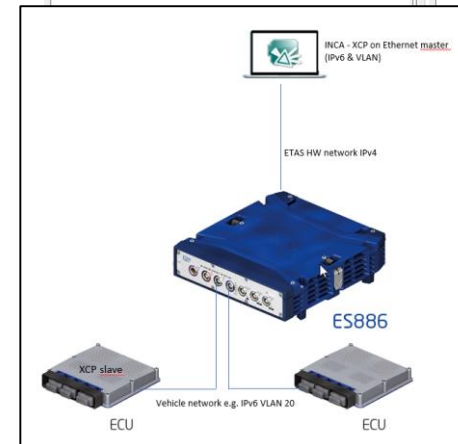

Available with INCA V7.4 SP1

Functionality

XCP VLAN, IPv4/IPv6 Tagged Communication via Vector Hardware (XCP on UDP)

- INCA supports now the XCP interface of the Vector hardware using the Network-Based Mode.
- Four new parameters are available for XCP to configure the IP communication independent from the PC settings.
- With this feature the PC doesn't need any IPv6 address or VLAN settings to communicate with an ECU in the vehicle network anymore.
- Supported HW: VN5430, VN5610(A), VN5611, VN5612, VN5620, VN5640, VN5650

Option	Value
Name	XCP-1
Meas. failure behavior	Abort after failure
Time stamp quantization	Off
Connection behavior	Reinitialize automatically
Project working data	
Reference Data	
Differences (bytes)	
Destination IP address (IPv4)	
Source Address	
Subnet mask/Prefix	
VLAN ID	
VLAN Priority	
Destination Port	
Source Port	
Ethernet Protocol Type	2
Log out behavior	No Automatic Flash Back
ECU Description Handling	ASAP2
Seed'n Key DLL	
Seed'n Key Privileges	0 DAQ, 0 CAL/PAG, 0 STIM, 0 PGM
Checksum DLL	
Fast Start	Fast start enabled: No
ECU Connect Mode	NORMAL
Confirm page switch	Yes
DAQ optimization	disabled
Counter Consistency Mode	one counter for all CTOs+DTOs
Check memory pages at initialization	Always check

Functionality

XCP VLAN – Use XCP Transport Layer Instance as Configuration Input for VLAN and IP Settings

To setup an OS independent XCP on UDP/TCP communication some additional parameters are required which are not yet available in the a2I file. To make the communication configuration setup more reliable INCA now supports the possibility to define these parameter within the Transport Layer Instance name.

Keys:

- IP_ (IPv4 or IPv6 source address)
- SUBNET_ (IPv4 subnet mask)
- PREFIX_ (IPv6 prefix length)
- VID_ (Vlan ID)
- VPRIO_ (VLAN priority)
- PORT_ (Source port)

Reference Data	XCPonUDP\XCPonUDP
Differences (bytes)	0
Transport Layer Instance	IPv6 UDI IP_1234:5678:9abc:def0:0:0:1:fff5 PREFIX_64 VID_1 VPRIO_0
Destination IP address (IPv6)	1234:5678:9abc:def0:0:0:1:fff4
Source Address	1234:5678:9abc:def0:0:0:1:fff5
Subnet mask/Prefix	64
VLAN ID	1
VLAN Priority	0
Destination Port	9002
Source Port	
Ethernet Protocol Type	UDP-IP

Functionality

COM-API – Add Key Value Pairs to MDF Recorder File

Additional info can be added to the recorder file while recorder is running or paused.

Recorder Configuration

User: Max Maier

Company: ETAS GmbH

Project:

Vehicle: S-XX 1234

INCA COM-API

```
oExp.AddXMLToHDBlockInMDF ("
<common_properties>
  <tree name=""TestBench7"">
    <tree name=""TestResults"">
      <e name=""Test1"">OK</e>
      <e name=""Test2"">Error_21</e>
    </tree>
  </tree>
</common_properties>
")
```

MDF-Explorer/Validator

myMeasureFile1.mf4 [Read]

<HDcomment xmlns="http://www.asam.net/mdf/v4">

- <TX>
- Database: test Experiment: Experiment - empty_auto_backup_2 Work
- </TX>
- <time_source>
- INCA PC Reference Time
- </time_source>
- <common_properties>
- <e name="subject">S-XX 1234</e>
- <e name="department">ETAS GmbH</e>
- <e name="author">Max Maier</e>
- <tree name="TestBench7" desc="">
- <tree name="TestResults" desc="">
- <e name="Test1" desc="" unit="" unit_ref="" type="string">OK</e>
- <e name="Test2" desc="" unit="" unit_ref="" type="string">Error_21</e>
- </tree>
- </tree>
- </common_properties>
- </HDcomment>

*MDA 8.6 Build 830 Con...

Home Configuration View Help

Information Window

[1] myMeasureFile1.mf4

Parameter	Value
File Name	[1] myMeasureFile1.mf4
File Path	C:\Temp\measure
File Format	MDF 4.10
Start Time	2022-05-16T12:40:41+02:00
User	Max Maier
Company	ETAS GmbH
Vehicle	S-XX 1234
Project	
Reference Page	Demo09_7 Date: 05/16/2022 Time: 12:4
Working Page	Demo09_34 RP: Demo09_7 Date: 05/16
File indexing	No index available

TestBench7

- TestResults
 - Test1 OK
 - Test2 Error_21

Functionality

COM-API – Reset Parameter to RP

INCA supports in the Experiment the possibility to reset parameter values. For this INCA copies the reference page value to the working page. INCA uses for this the raw values from the ECU memory to get the exact copy.

For this INCA introduces the method `ResetValueToRP()` for `CalibrationDataItem`s.

`CalibrationDataItem`.**ResetValueToRP()**

Functionality

COM-API – Support further INCA User Options by Get- / Set-Option

INCA supports the possibility to get and set user options via the COM-API.

New introduced options to get / set

MDF write compressed (Yes / No) ¹⁾

USEROPTIONS [Measure-General]**MdfCompressed()**

MDF indexed (No / ETAS / Standard)

USEROPTIONS [Measure-General]**WriteIndexToMeasureFile()**

Base name of MDF file (text) ²⁾

USEROPTIONS [Measure-General]**MeasureFileName()**

¹⁾ For set the Experiment must be closed

²⁾ Variables are allowed in the file name

Functionality

DBB – Navigate to assigned Project in DB-View

Navigating to (“Jumping”) to project

- from HWC or HWC tree view
- selects the project in database browser and makes it visible

Available via:

- Context Menu on device
- Context menu on project field
- Easy access feature
- hotkeys

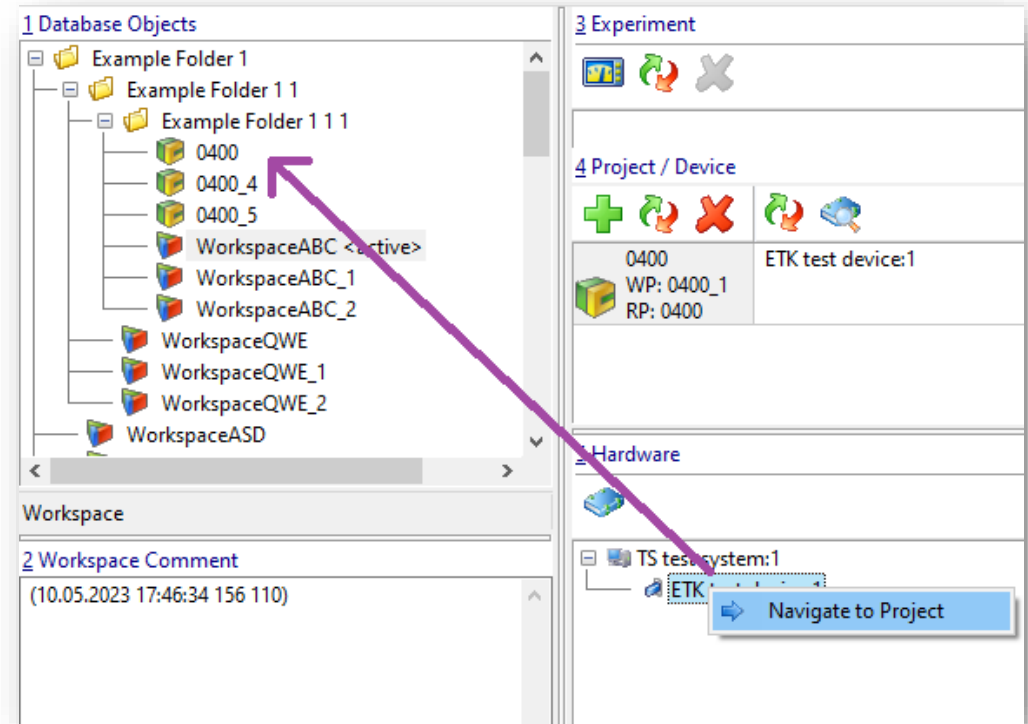

Available with INCA V7.4 SP5

Functionality

CDM – Date / Time Variables in Output File Name

Additionally to the existing \$-variables CDM supports now detailed date and time variables.

This allows to create individual time formats

Variable	Description	Example output
dd	Current date - the day of the month	"01", "31"
MM	Current date - the month of the year	"01", "12"
yyyy	Current date - the year	"2022"
yy	Current date - the year	"18"
hh	Current date - the hour of the day 00 – 12	"12"
HH	Current date - the hour of the day 00 – 24	"24"
mm	Current date - the minute of the hour	"59"
ss	Current date - the second of the minute	"50"
tt	Current date - the PM/AM designator	"AM"

Preview of current variable values

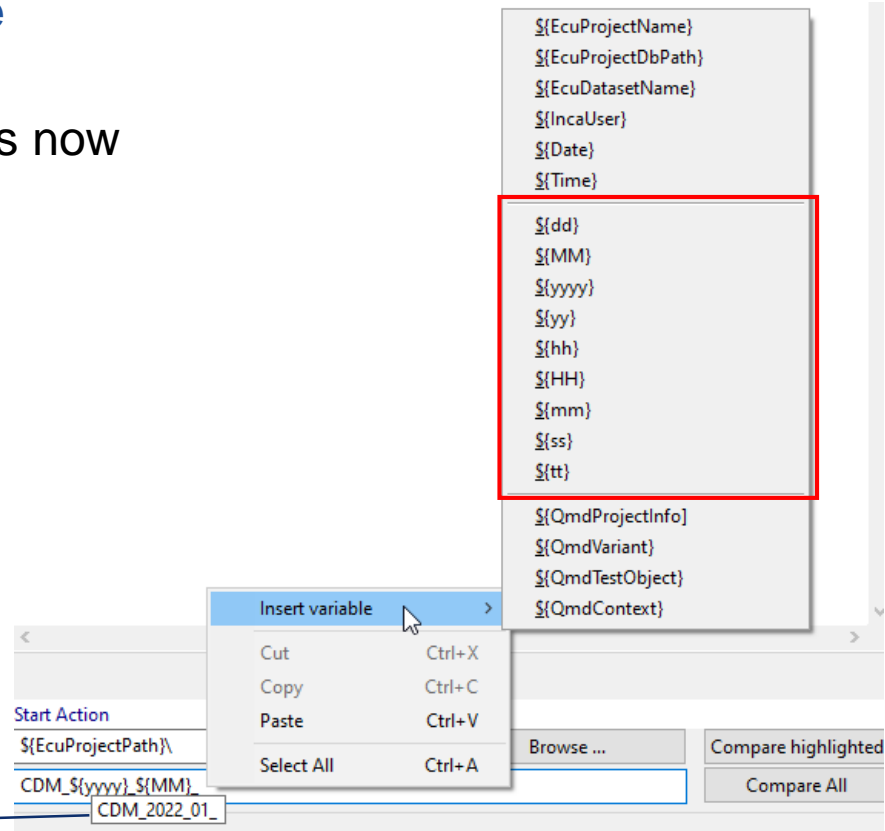

Functionality

CDM – Grid Editor

Edit destination data sets directly

- No more change between destination and source necessary
- Double click to open the Grid Editor
- CDM selects the type of editor dependent on the parameter type
- CDM opens the editor near to the selected cell
- Former editors stay in parallel
 - Inline editor
 - HTML view
 - Experiment view

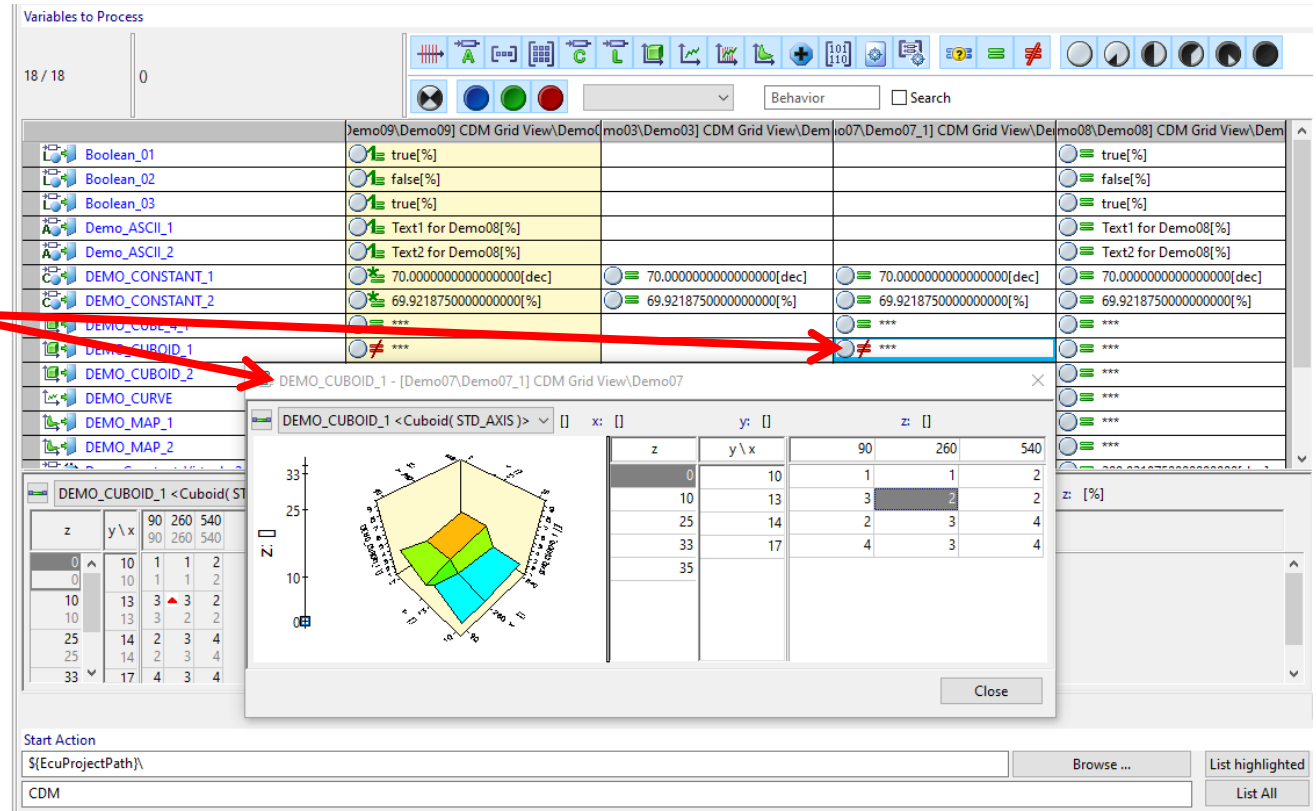

Functionality

CDM – List Datasets in Batch Operation

To write CDM destination data sets as data exchange file it is necessary to get the used destination data sets from CDM.

INCA offers now the possibility to request via API from CDM the currently used data sets.

string[] EtasCDMToolbox.GetDestinations()

Returns a list with complete paths for the destination data sets / files used in CDM

Together with the methods SetSourceDataSet() and List() the different data sets can be written by batch operation as data exchange file.

Functionality

INCA writes GROUP and FUNCTION Information into MDF file

For signals recorded with INCA additional meta information from an A2L file are stored in an MDF V4 measure file.

- The default number of decimals for signal values (A2L file “FORMAT” -> MDF V4 file “cn_precision”)
- The FUNCTION and GROUP information (to be activated by a User Option)

Thus an analysis tools like MDA can read this information and use it for a faster selection of the needed signals, and to display signal values with a reasonable number of decimals.



ECU Description File (A2L)

Property	Value
Address	0xF68C (Internal)
Bitmask	0xFF
Bounds	[0.0...255.0]
Byte order	MSB_LAST
Data type	UBYTE
Format	%8.4
Formula	OneToOne_UB
Functions	UKSEFI
Longname	Last-Steigerung
Measure range	[0.0...255.0]



Measure File (MDF V4.x)

Functionality

Device Specific Filter – Usability Improvements

Experiment - Variable Name Display Setup Dialog

- Filter area's behavior depending on selected list entry
 - 1) Global Filter settings without title, as before
 - 2) System No filters settings, as before
 - 3) Device The device's path name is title of the filter settings. The device's parent systems are reachable via link.
- Open Variable Name Display Setup Dialog for last selected list entry, this is valid per experiment session

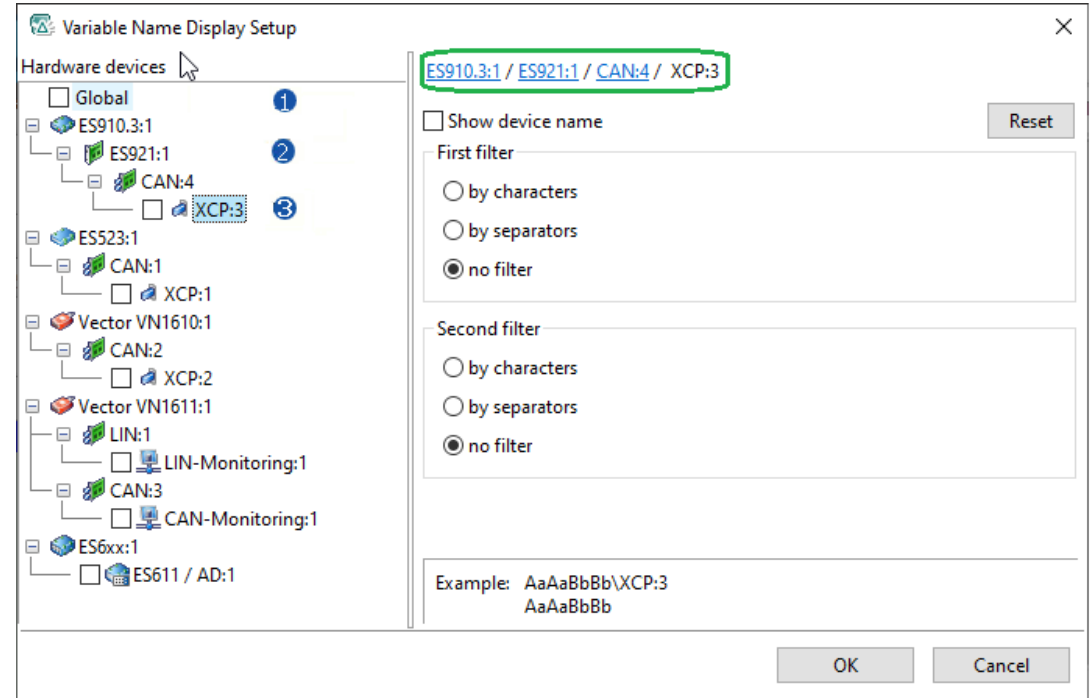

Functionality

XCP – OS independent Communication Stack extended by full TCP Support

- INCA offers now the full functionality to communicate OS independent over UDP and TCP via XCP.
- The OS independent IP stack allows INCA to support VLAN tagged communication. IPv4 and IPv6 communication is possible independent of the IP setting of the OS.
- Supported HW: ES886.2, Vector Ethernet network devices and local Network Interface Cards on the Windows PC.

Option	Value
Name	XCP:1
Meas. failure behavior	Abort after failure
Time stamp quantization	Off
Connection behavior	Reinitialize automatically
Project working data	DEFAULT_TLIN_example XCPonUDP;XCPonUDP_1
Reference Data	XCPonUDP;XCPonUDP
Differences (bytes)	0
Transport Layer Instance	IPv6 UDP IP_1234:5678:9abc:def0:0:0:1:fff5 PREFIX_64 VID_1 VPRI0_0
Destination IP address (IPv6)	1234:5678:9abc:def0:0:0:1:fff4
Source Address	
Subnet mask/Prefix	
VLAN ID	
VLAN Priority	
Destination Port	9002
Source Port	

Functionality

Experiment – Improved handling of Variables in Save Measure File Dialog ‘Output Properties’

For the file name of a recording a template can be defined. It might include Variables, like a counter (e.g. "&[CNT1]"), the date (e.g. "&[yyyy]-&[MM]-&[dd]"), and others.

When saving the recording the variable's values are updated with the values valid in this moment.

The user can still modify the file name manually.

To make it transparent which contents are variables, now the 'Output File Properties' dialog indicates the variables, and shows a preview for the actual file name.

Via a checkbox the manual changes can be stored back into the template and will be used as default for the next recording

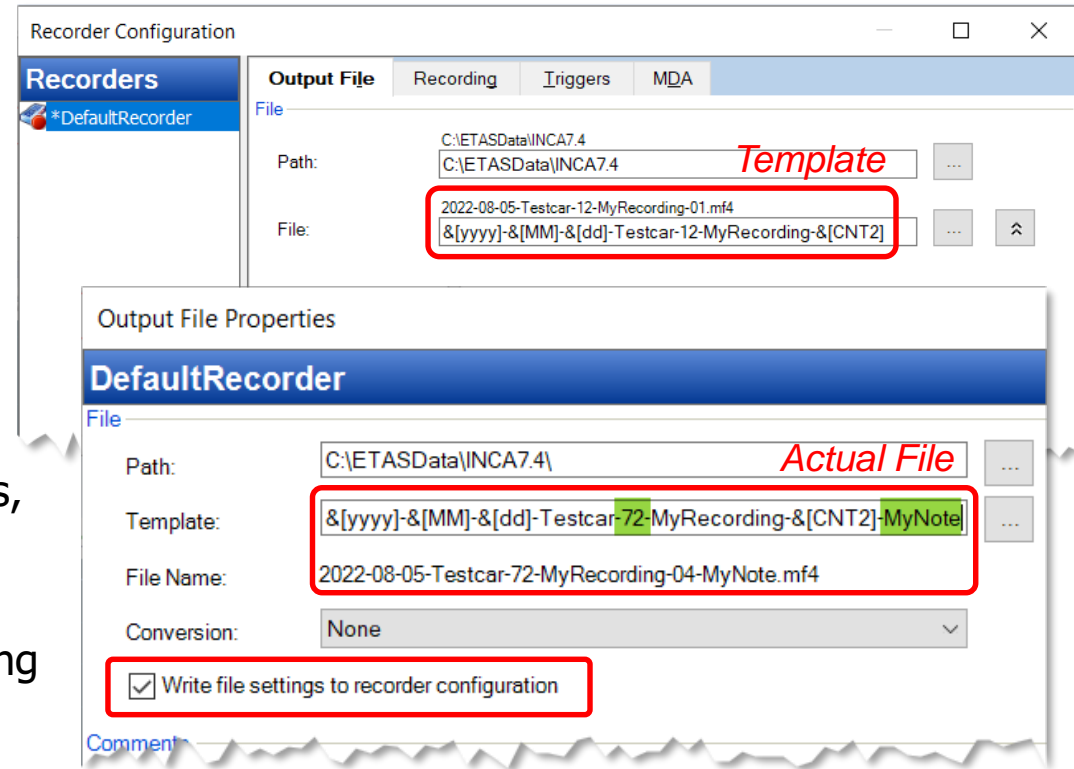

Available with INCA V7.4 SP2

Functionality

Experiment – Deactivating a (XCP-) Connection without closing INCA or EE

Let the ECU go into sleep mode without being interrupted by cyclic XCP requests

- Menu to disable/enable sending of cyclic XCP commands
- Cyclic XCP commands for connection status and time synchronization are suppressed
- Measurement and calibration can still be used (but XCP commands will interrupt sleep mode)
- COM API support

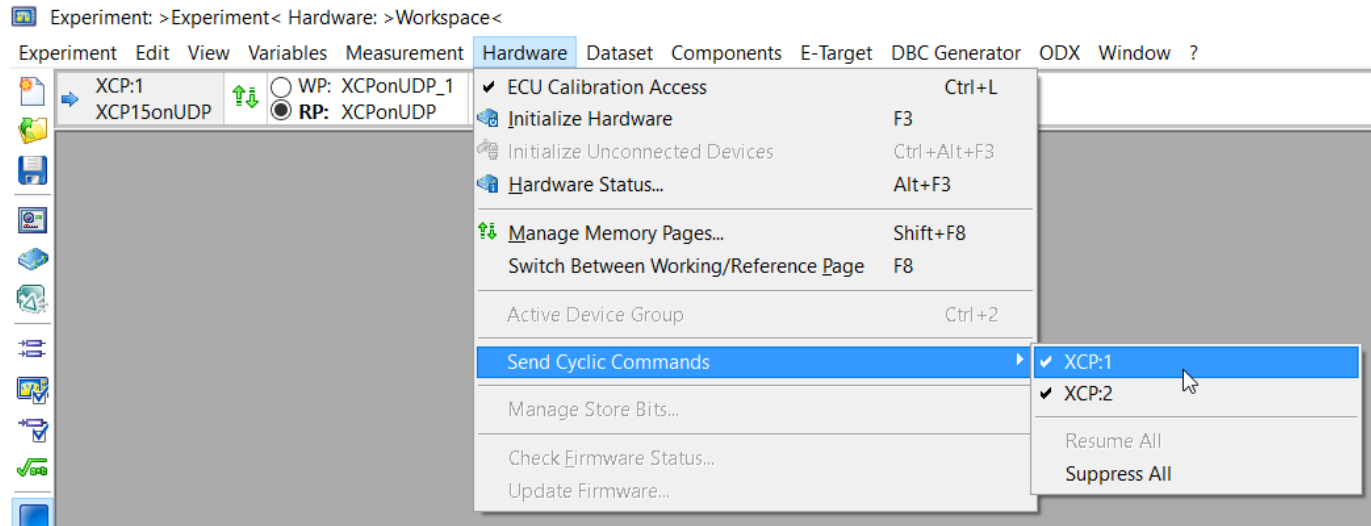

Functionality

Experiment – Editors – Sort by Device

INCA allows in the variable order dialog to sort variables by device name

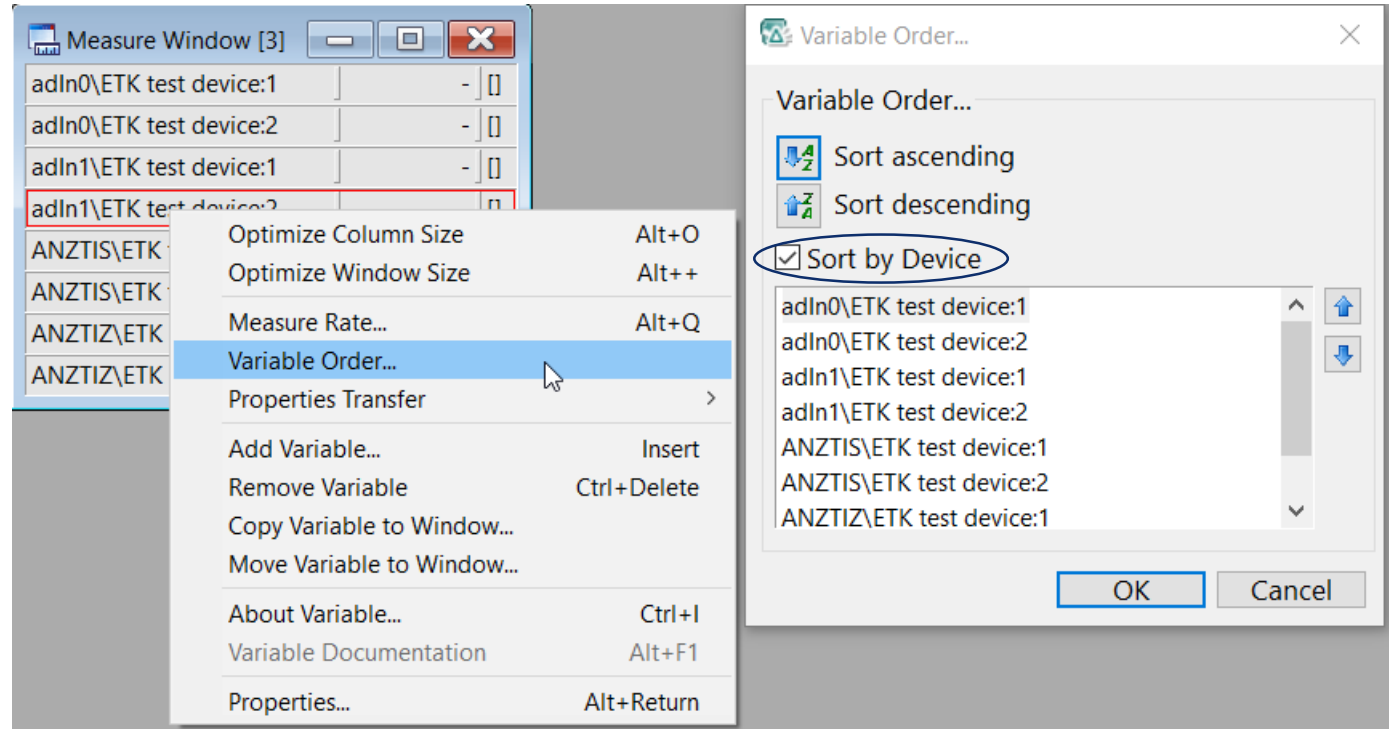

Functionality

VSD – New Document Format in "Export Variables for Excel"

INCA offers in the Variable Selection Dialog VSD the possibility to write the selected variables as Excel overview.

Now INCA uses the common **Workbook Format .xlsx**

Name	Data Source	Address	Bytes	Syncro	TimeB	TimeC	[Virtual]	Leading_All	Leading_X	Leading_Y	10ms	50ms	100ms	500ms
B_GREEN	ETK test device: 1	0x5B	0x1[1]											
B_RED	ETK test device: 1	0x5B	0x1[0]	X										
B_YELLOW	ETK test device: 1	0x5B	0x1[2]			X								
DEMO_CONSTANT_1	ETK test device: 1	0xB697	0x1											
DEMO_CONSTANT_1.Output	ETK test device: 1													
DEMO_CONSTANT_2	ETK test device: 1	0xB5D3	0x1											
DEMO_CONSTANT_2.Output	ETK test device: 1												X	
DEMO_CURVE	ETK test device: 1	0xD3EF	0xF											
DEMO_CURVE.Output	ETK test device: 1													
DEMO_MAP_1	ETK test device: 1	0xC469	0x78											
DEMO_MAP_1.Output	ETK test device: 1									X				
DEMO_MAP_2	ETK test device: 1	0xC5E1	0xC4											
DEMO_MAP_2.Output	ETK test device: 1													
Input_1	ETK test device: 1	0x6C	0x1	X										
Input_2	ETK test device: 1	0x71	0x1			X								
Output	ETK test device: 1	0xFD02	0x1											

Available with INCA V7.4 SP2

INCA V7.4 – What's New

Functionality

VSD – Possibility to create LAB Files more specifically

To enable creation of a LAB file for a specific set of variables the tree view in the Display Configuration and the Variables Configuration offers an additional context menu entry.

The entry "Create Lab file..." is available for

- the main node 'Experiment'
- the Recorder and Virtual Measurement nodes
- each layer node
- and each instrument node

The following Save File dialog allows to define the LAB file format version.

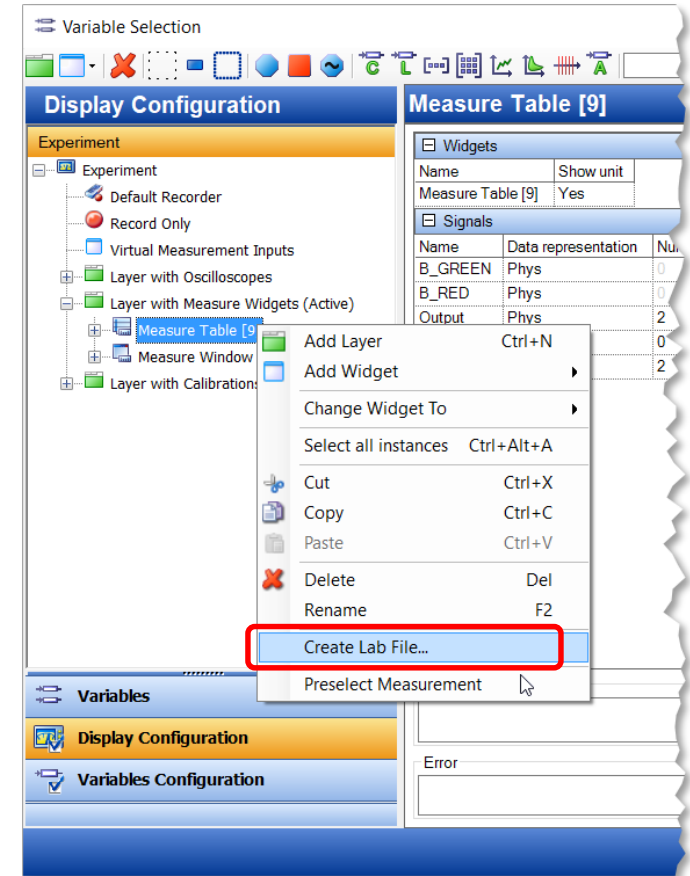

Functionality

VSD – Select all recorders in Variable Configuration Tab

The VSD allows now to

1. see all recorders in the experiment structure
2. select / de-select the variables in all recorders
3. sort the variables by the selection state in the recorders

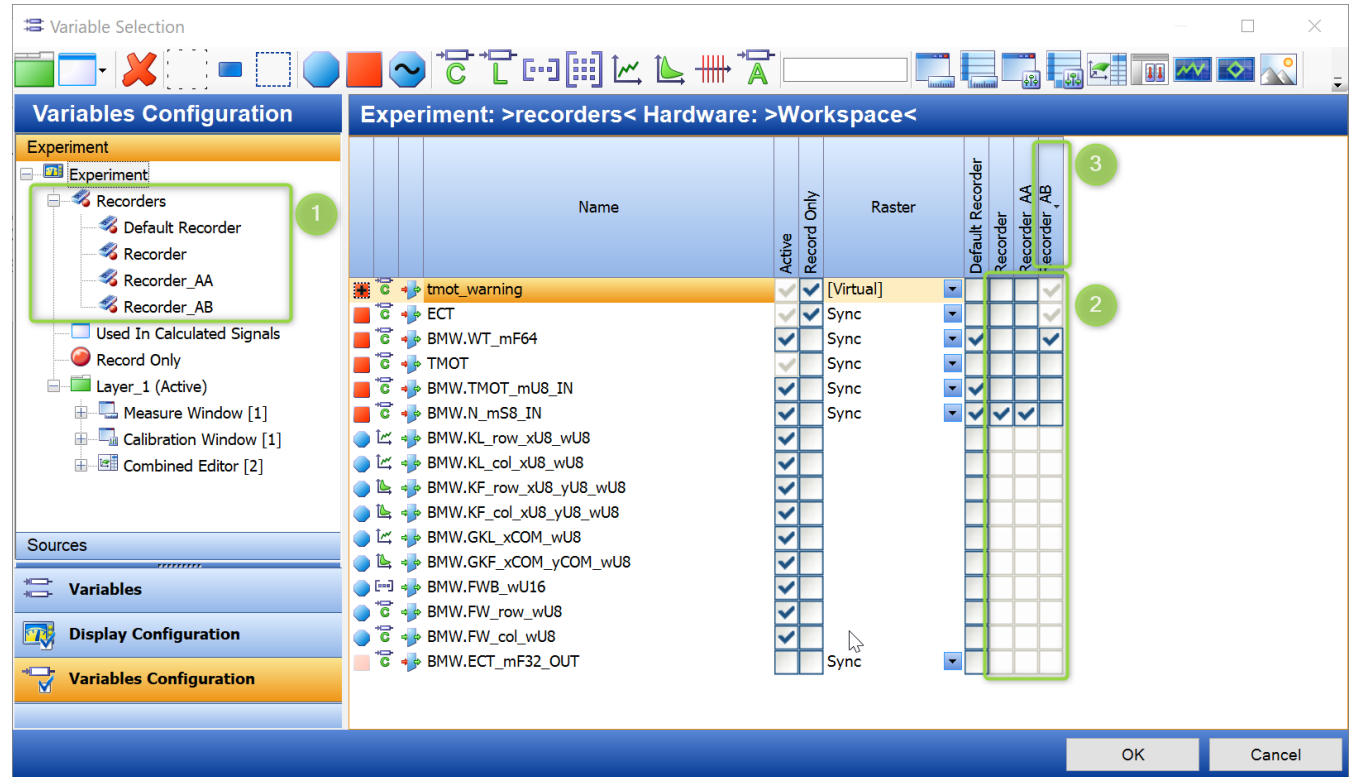

INCA V7.4 – What's New

Functionality

MDF – Array Index without Underline

INCA breaks down measurement arrays to single cells. Each cell gets an index.

By the option the index gets a leading underscore or not:

"MyArray_**[0]**" / "MyArray**[0]**"

Affected

- Experiment Representation
- LAB files, MDF files
- Recorder, Trigger, Calculated Signals
- COM API

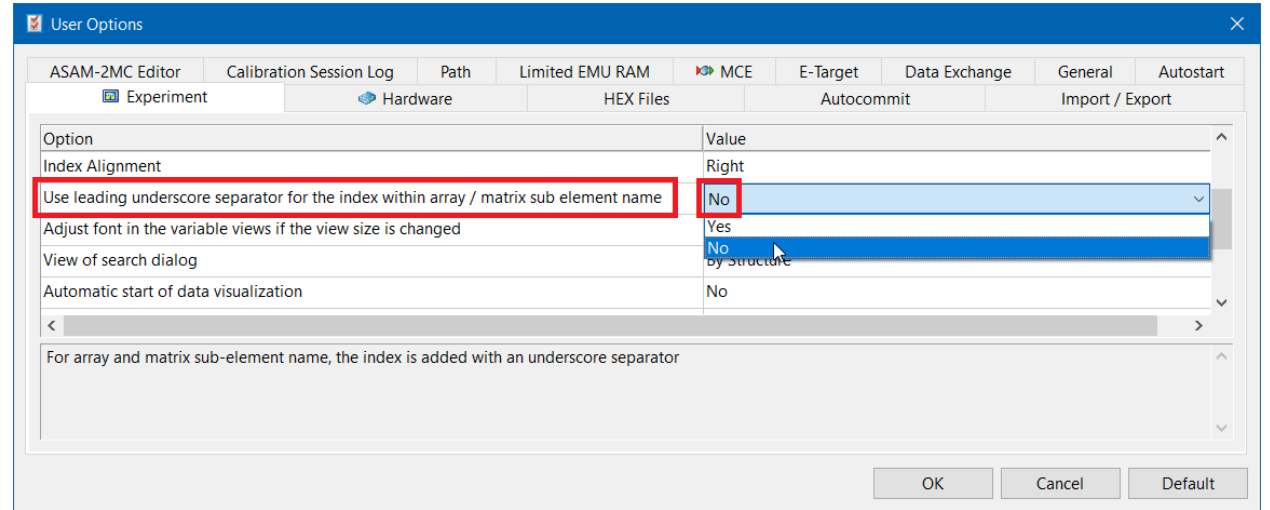

Allows to adapt the INCA array handling to individual work flows!

Functionality

ETK Related Features

- Release of BR_XETK-S4.0B
- Release of BR_XETK-S3.0C

- Display the Device ID of the Default Device Selection for the HWC Device Selection

- Store and use device dependent HWC configuration parameters

XETK	
[-] XETK-S20	
Autostart Behavior	Last Active Page
Overload Error Behavior	Stop Measurement
Device Selection (A2L File)	Default INCA Device Selection (Device ID '4')
Code Check Error Behavior	Default INCA Device Selection (Device ID '4')
	A2L Device with Device ID '4'
	A2L Device with Device ID '5'
	A2L Device with Device ID '6'
	A2L Device with Device ID '7'

XETK	
[-] BR_XETK-S3	
Autostart Behavior	Last Active Page
Overload Error Behavior	Stop Measurement
Device Selection (A2L File)	A2L Device with Device ID '1'
Code Check Error Behavior	No Reset
Calibration Wakeup	Enabled

XETK	
[-] BR_XETK-S3	
Autostart Behavior	Last Active Page
Overload Error Behavior	Drop Data and Continue Measurement
Device Selection (A2L File)	A2L Device with Device ID '2'
Code Check Error Behavior	No Reset
Calibration Wakeup	Enabled

Functionality

ETK / XETK / FETK

New Device Support

- Support of FETK-T5 (for the NXP μ C S32G and S32Z)

Device Communication

- The device alias is displayed in INCA monitor messages for a better identification of the source of the messages

INCA-HWC Parameters

- Remove the “Code Check Error Behavior” parameter to avoid confusion
- Support of XCP Multi Master measurement with DISTAB 17 (depends on Device type)

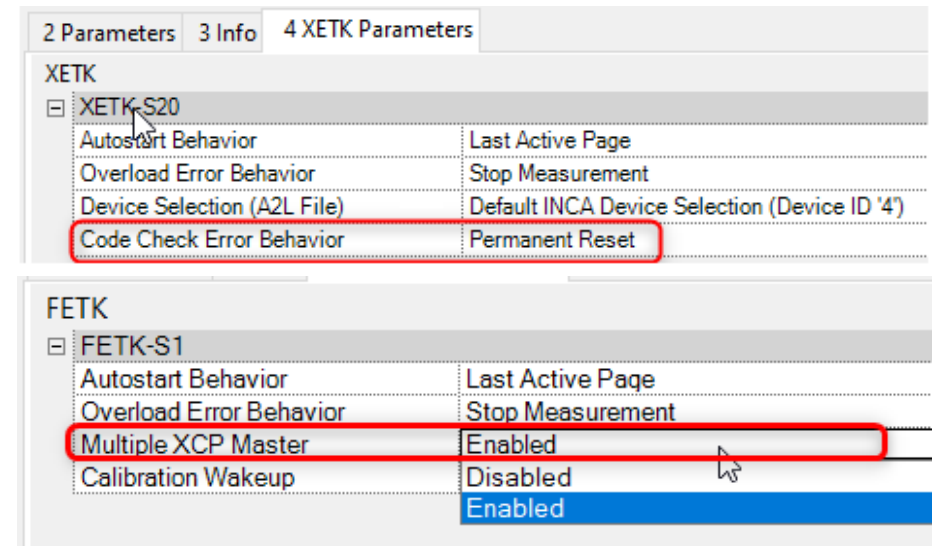

Available with INCA V7.4 SP4

Functionality

HWC – Support VX Configuration File upload to VX Device

The Vector VX devices need to be configured with a lot of parameters. This is typically done with the VX config tool which can export a configuration file. INCA now allows to upload such a configuration file directly to a VX device. The user can read different configuration files to the INCA database and can assign such a database item to a specific VX device in the hardware configuration dialog. The user only has to execute the upload manually on demand.

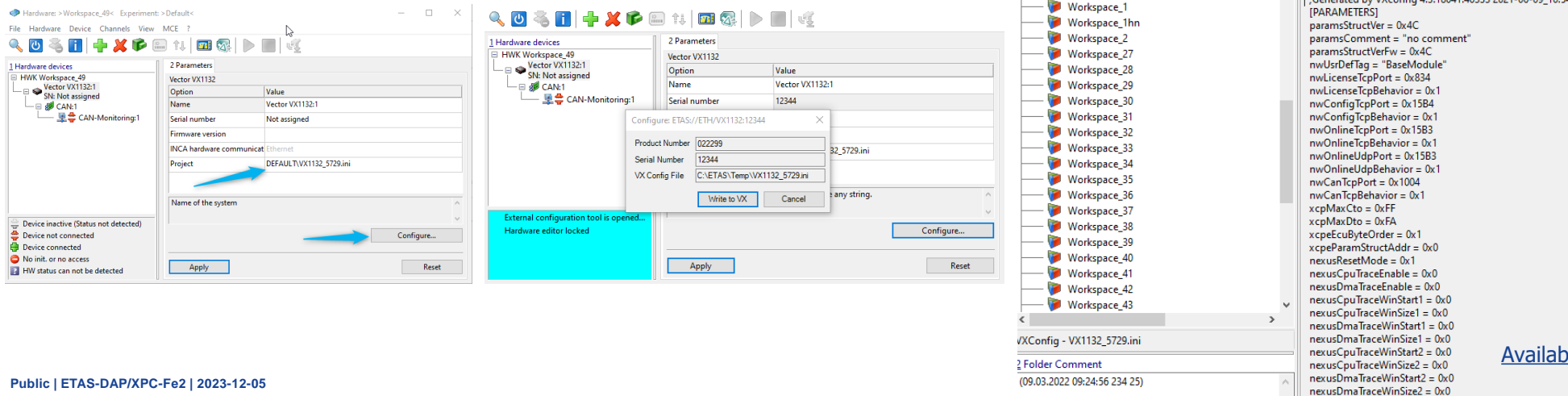

Available with INCA V7.4 SP1

Functionality

HWC – Make Ethernet Filter Setting configurable

Sometimes the Autosar description file does not fit completely to the frames on the bus. INCA offers now the possibility to configure the parameter used to filter the frames from the Ethernet interface.

This functionality is supported for Some/IP and Ethernet monitoring.

The screenshot shows the INCA interface with the following structure:

- 1 Hardware devices
 - HWK Workspace_50
 - ES8xx:1
 - ES886.2:1 (SN: Not assigned AN: Not assigned)
 - ETH:1
 - Ethernet-Monitoring:1

2 Parameters		3 Ethernet-Monitoring Parameters	
Ethernet Monitoring			
Configure Ethernet capture filters			
MAC addresses		ignored	
VLAN IDs		checked	
IP addresses		checked	
Ports		checked	

The screenshot shows the INCA interface with the following structure:

- 1 Hardware devices
 - HWK Workspace_50
 - ES8xx:1
 - ES886.2:1 (SN: Not assigned AN: Not assigned)
 - ETH:1
 - SOME/IP-Monitoring:1

2 Parameters		3 SOME/IP-Monitoring Parameters	
SOME/IP Monitoring			
Configure SOME/IP capture filters			
MAC addresses		ignored	
VLAN IDs		checked	
IP addresses		checked	
Ports		checked	

Functionality

HWC – De-assign Project

De-assigning project possible inside HWC

Available via:

- Context Menu on device
- Context menu on project field
- Easy access feature
- hotkeys

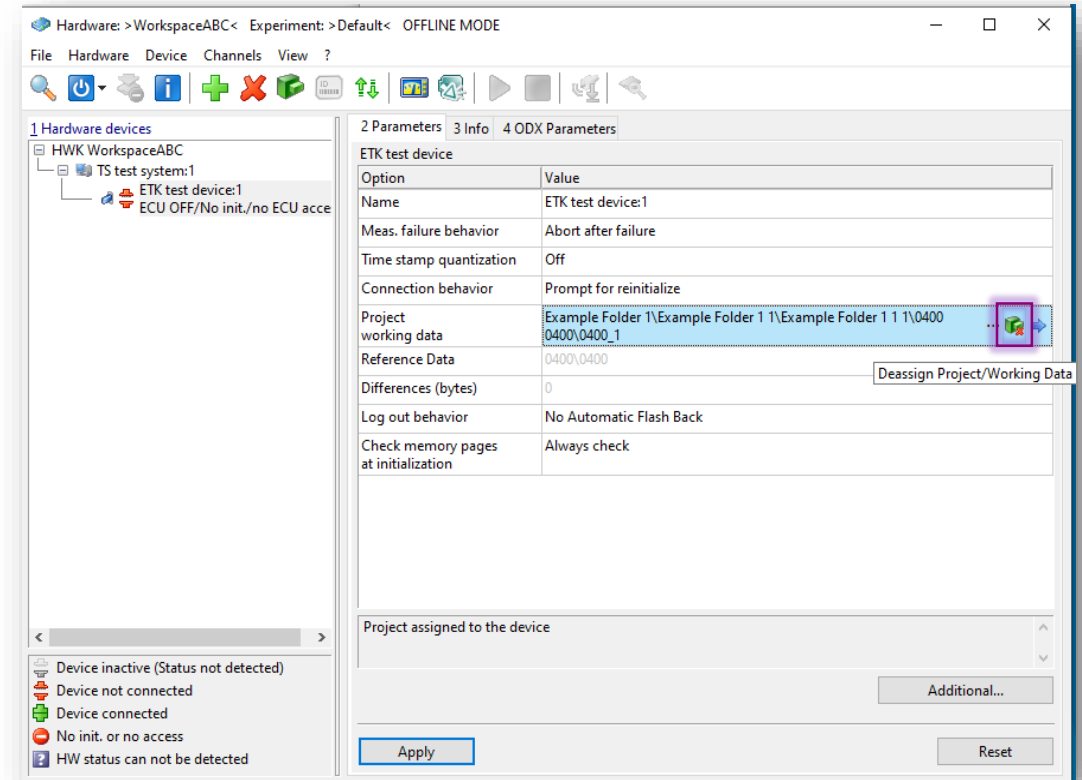

Available with INCA V7.4 SP5

Functionality

HWC – Assign Project Dialog improvements - provide “search for Project” functionality

- Search controls** for project and dataset column
 - Focus decides which tree the search is used on
 - Collapse/Expand all possible for both sites
- Search always starts from the selected node
- Search supports asterisks (*)
- Dataset search works for name + user

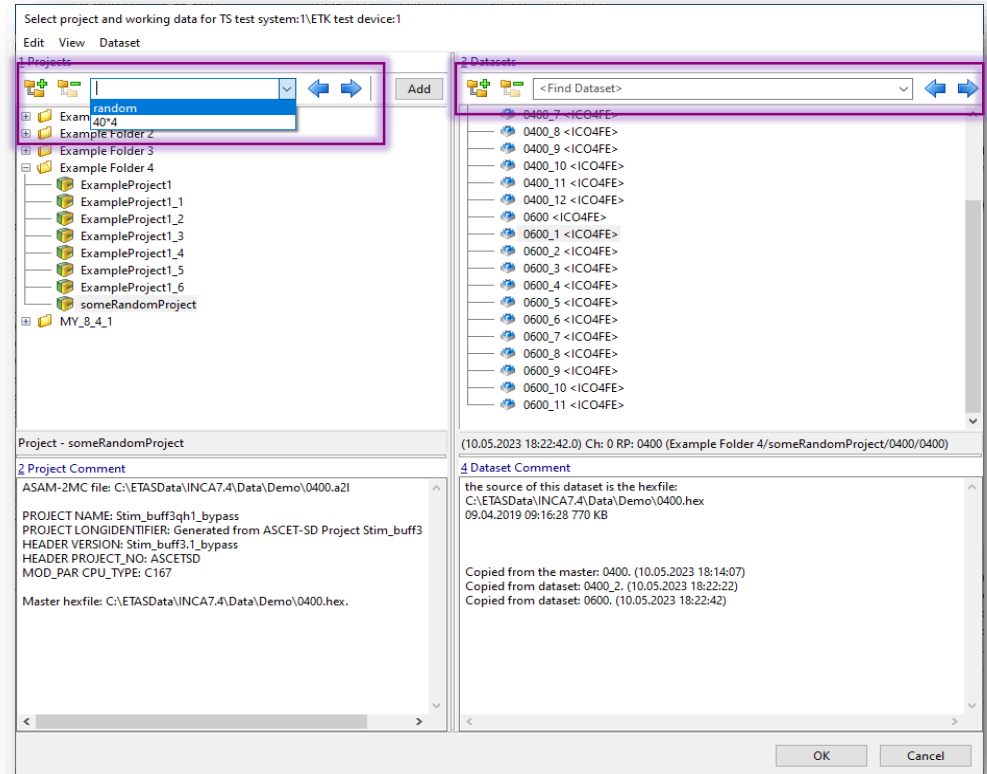

Functionality

HWC – Allow to deactivate automatic HW Re-Init after Flashing

Allow flashing of multiple (sibling) devices with a lower number of reinitializations by

- making the MPM **support multiple devices**
- allowing **devices to stay unloaded** during MPM session executing multiple flash operations
- take advantage of new user option to configure “Reinitialization after Flashing behavior”

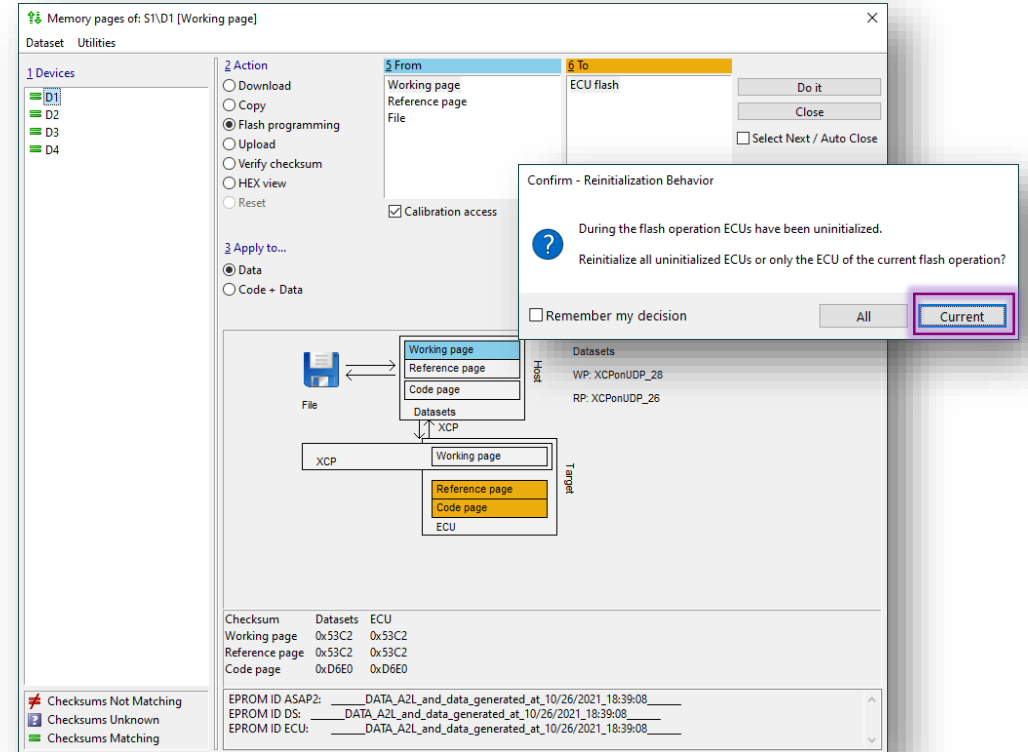

Functionality

LAB File Format V1.3 – Extended Support for Device Information

The device name allows to differentiate between labels of different devices

Allows to filter across multiple devices by using the LAB file for the selection

same
label
name

```
[SETTINGS]
Version;V1.3
MultirasterSeparator;&
```

```
[RAMCELL]
ASAM.M.SCALAR.FLOAT64.IDENTICAL;Engine_1;;;ETK_test_device:2
ASAM.M.SCALAR.SBYTE.IDENTICAL;Engine_1;;;ETK_test_device:2
ASAM.M.SCALAR.SBYTE.IDENTICAL;Engine_1;;;ETK_test_device:1
ASAM.M.SCALAR.SLONG.IDENTICAL;Engine_1;;;ETK_test_device:2
ASAM.M.SCALAR.UBYTE.IDENTICAL;Engine_1;;;ETK_test_device:1
```

different
device

```
[LABEL]
ASAM.C.CURVE.STD_AXIS;;;ETK_test_device:1
ASAM.C.SCALAR.SBYTE.IDENTICAL;;;ETK_test_device:2
ASAM.C.SCALAR.SWORD.IDENTICAL;;;ETK_test_device:1
ASAM.C.SCALAR.SWORD.LINEAR_MUL_2;;;ETK_test_device:1
```

[LAB File Specification](#)

Available with INCA V7.4 SP3

Functionality

LAB File - UI Improvements

In VSD a new command „Reload LAB File“ was introduced and the existing „Remove LAB File“ improved

- it is possible to reload a LAB file after editing in an external editor
- both commands work also for multi selected LAB files

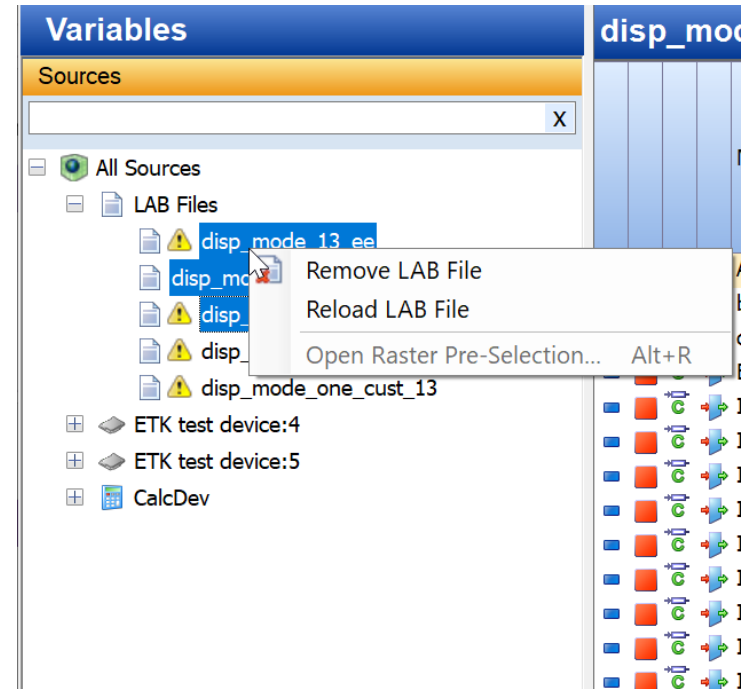

Functionality

LAB File - Handling

In VSD and EE the Display Mode is written out into LAB files when the format version 1.2 or newer is selected

```
[SETTINGS]
Version;V1.3
MultirasterSeparator;&

[RAMCELL]
boolean_vtab_u8_bit2;Sync;Display;;ETK test device:4
cs;[Virtual];Display;;CalcDev
ECT;100ms;Display;;ETK test device:4
Input_1;Sync;RecordingOnly;;ETK test device:4
Input_10;Sync;RecordingOnly;;ETK test device:4
Input_11;Sync;RecordingOnly;;ETK test device:4
Input_12;Sync;RecordingOnly;;ETK test device:4
Input_2;Sync;Display;;ETK test device:4
Input_3;Sync;Display;;ETK test device:4
Input_4;Sync;Display;;ETK test device:4
Input_5;Sync;Display;;ETK test device:4
Input_6;Sync;Display;;ETK test device:4
Input_7;Sync;Display;;ETK test device:4
Input_8;Sync;Display;;ETK test device:4
Input_9;Sync;Display;;ETK test device:4
N;Sync;DisplayOnly;;ETK test device:4
TMOT;100ms;Display;;ETK test device:4
```

Functionality

Virtual Networks – Support CAN/CAN-FD Monitoring

Virtual Networks – Bus Monitoring parallel with XCPSimTime on Ethernet

- INCA supports CAN FD monitoring for the ETAS VNET CAN simulation.
- The handling of description files is the same as for a real CAN hardware.
- In parallel the XCPSimTime device can measure simulation internal data.
- The time stamps of both data sources are expected to origin from the same clock to be aligned in the measure file.

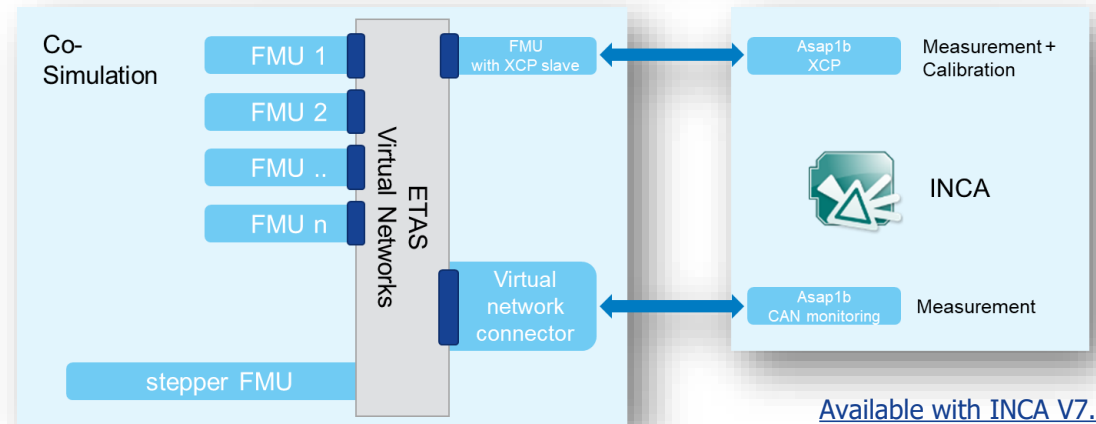
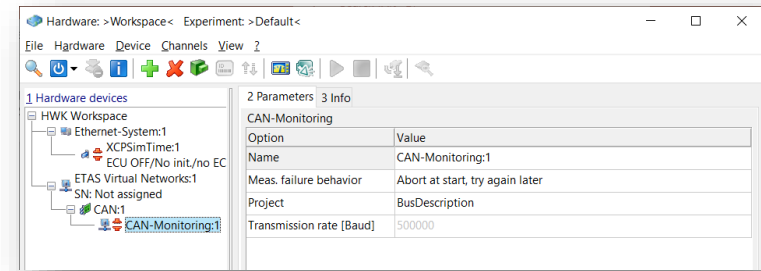

Available with INCA V7.4 SP4

INCA V7.4 – What's New

Functionality

INCA – Use Windows default browser

Standardize web browser usage throughout INCA e.g. in CDM, OBD, HWC and upcoming features

Shows all system installed browsers
<system default browser> is default setting

Changes to windows default browser are detected
Sharing between PCs/users is possible via Import/Export
If browser is not installed, defaults to system default

No INCA browser set shows error on browser open action

INCA browser path can be obtained via COM API

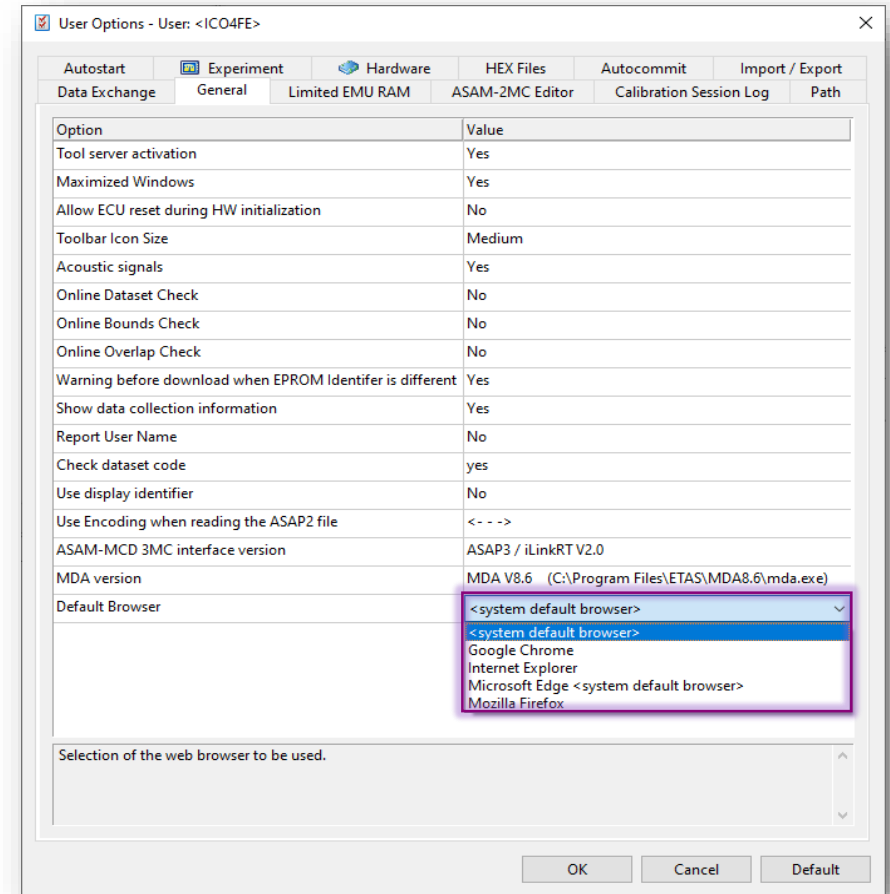

Available with INCA V7.4 SP4

INCA V7.4 – What's New

Functionality

Dynamic link in the HWC to Web-Interface of ETAS devices

Improved access to web interface for ETAS systems

IP address field shown in parameters tab
(Only shown if contained in search result)

Multiple ways to open the web interface:

- Device context menu – “Configure...”
- Double click on IP address
- Click on “Configure...” button in Parameters tab
(like opening external config module e.g. Daisy Chain)

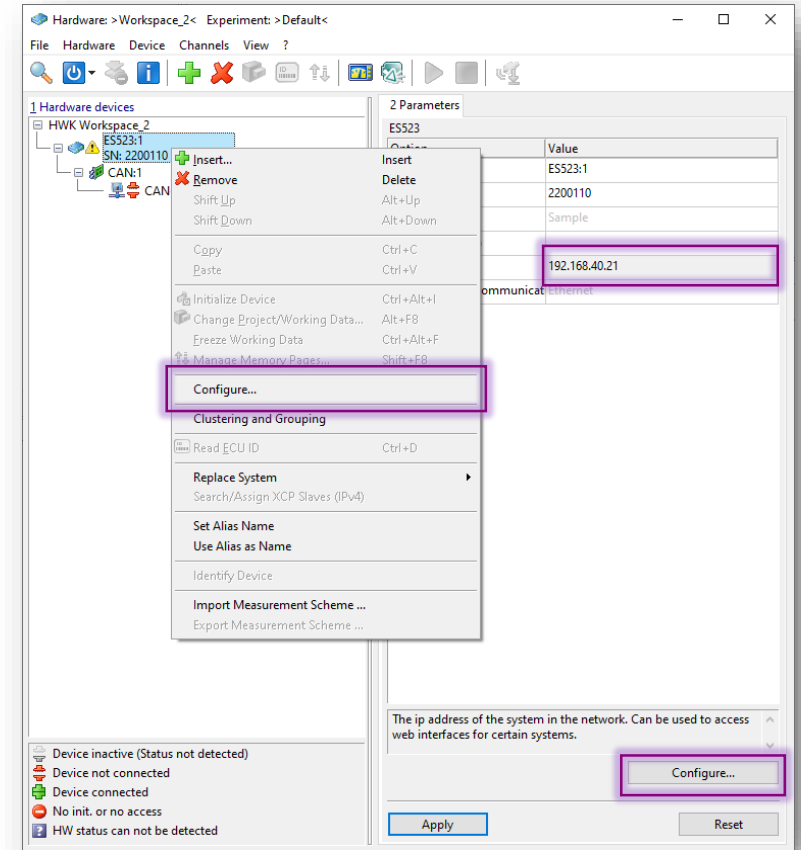

Available with INCA V7.4 SP4

INCA V7.4 – What's New

Functionality

INCA – Stop Windows shut down

If the user signs out in windows or triggers shutdown, INCA will give an Information, that it is still running

Cancelling the shut down gives a chance to

- Continue a running measuring
- Save changes

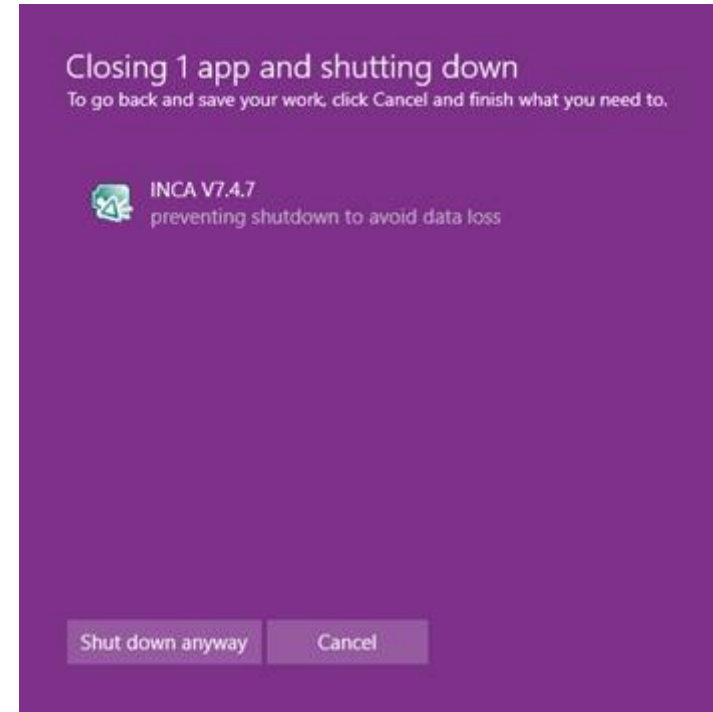

Functionality

VSD – Improved display of measure array selection states

The main view in the variable selection dialog shows

- No cell selected
- Some cells selected
- All cells selected
- By clicking directly in the main all cells will be selected

The measure array selection view shows the detailed selection

Main view

Name	segment_synchro...	segment_synchro...	10ms time synchro...	10ms Mo time sy...	100ms time syncr...	1ms time synchr...	1000ms time syn...	5ms time synchr...	20ms time synchr...	NW_Sensor
_Clu0_posnAry_VW	<input checked="" type="checkbox"/>	<input checked="" type="checkbox"/>	<input checked="" type="checkbox"/>	<input checked="" type="checkbox"/>	<input checked="" type="checkbox"/>	<input checked="" type="checkbox"/>	<input checked="" type="checkbox"/>	<input checked="" type="checkbox"/>	<input checked="" type="checkbox"/>	<input checked="" type="checkbox"/>



Measure Array Selection view

Name	segment_synchro...	segment_synchro...	10ms time synchro...	10ms Mo time sy...	100ms time syncr...	1ms time synchr...	1000ms time syn...	5ms time synchr...	20ms time synchr...	NW_Sensor
_Clu0_posnAry_VW_[0]	<input checked="" type="checkbox"/>	<input checked="" type="checkbox"/>	<input checked="" type="checkbox"/>	<input checked="" type="checkbox"/>	<input checked="" type="checkbox"/>	<input checked="" type="checkbox"/>	<input checked="" type="checkbox"/>	<input checked="" type="checkbox"/>	<input checked="" type="checkbox"/>	<input checked="" type="checkbox"/>
_Clu0_posnAry_VW_[1]	<input checked="" type="checkbox"/>	<input checked="" type="checkbox"/>	<input checked="" type="checkbox"/>	<input checked="" type="checkbox"/>	<input checked="" type="checkbox"/>	<input checked="" type="checkbox"/>	<input checked="" type="checkbox"/>	<input checked="" type="checkbox"/>	<input checked="" type="checkbox"/>	<input checked="" type="checkbox"/>
_Clu0_posnAry_VW_[2]	<input checked="" type="checkbox"/>	<input checked="" type="checkbox"/>	<input checked="" type="checkbox"/>	<input checked="" type="checkbox"/>	<input checked="" type="checkbox"/>	<input checked="" type="checkbox"/>	<input checked="" type="checkbox"/>	<input checked="" type="checkbox"/>	<input checked="" type="checkbox"/>	<input checked="" type="checkbox"/>
_Clu0_posnAry_VW_[3]	<input checked="" type="checkbox"/>	<input checked="" type="checkbox"/>	<input checked="" type="checkbox"/>	<input checked="" type="checkbox"/>	<input checked="" type="checkbox"/>	<input checked="" type="checkbox"/>	<input checked="" type="checkbox"/>	<input checked="" type="checkbox"/>	<input checked="" type="checkbox"/>	<input checked="" type="checkbox"/>
_Clu0_posnAry_VW_[4]	<input checked="" type="checkbox"/>	<input checked="" type="checkbox"/>	<input checked="" type="checkbox"/>	<input checked="" type="checkbox"/>	<input checked="" type="checkbox"/>	<input checked="" type="checkbox"/>	<input checked="" type="checkbox"/>	<input checked="" type="checkbox"/>	<input checked="" type="checkbox"/>	<input checked="" type="checkbox"/>
_Clu0_posnAry_VW_[5]	<input checked="" type="checkbox"/>	<input checked="" type="checkbox"/>	<input checked="" type="checkbox"/>	<input checked="" type="checkbox"/>	<input checked="" type="checkbox"/>	<input checked="" type="checkbox"/>	<input checked="" type="checkbox"/>	<input checked="" type="checkbox"/>	<input checked="" type="checkbox"/>	<input checked="" type="checkbox"/>
_Clu0_posnAry_VW_[6]	<input checked="" type="checkbox"/>	<input checked="" type="checkbox"/>	<input checked="" type="checkbox"/>	<input checked="" type="checkbox"/>	<input checked="" type="checkbox"/>	<input checked="" type="checkbox"/>	<input checked="" type="checkbox"/>	<input checked="" type="checkbox"/>	<input checked="" type="checkbox"/>	<input checked="" type="checkbox"/>

Available with INCA V7.4 SP7

Functionality

Export for DAQ based measurement configuration

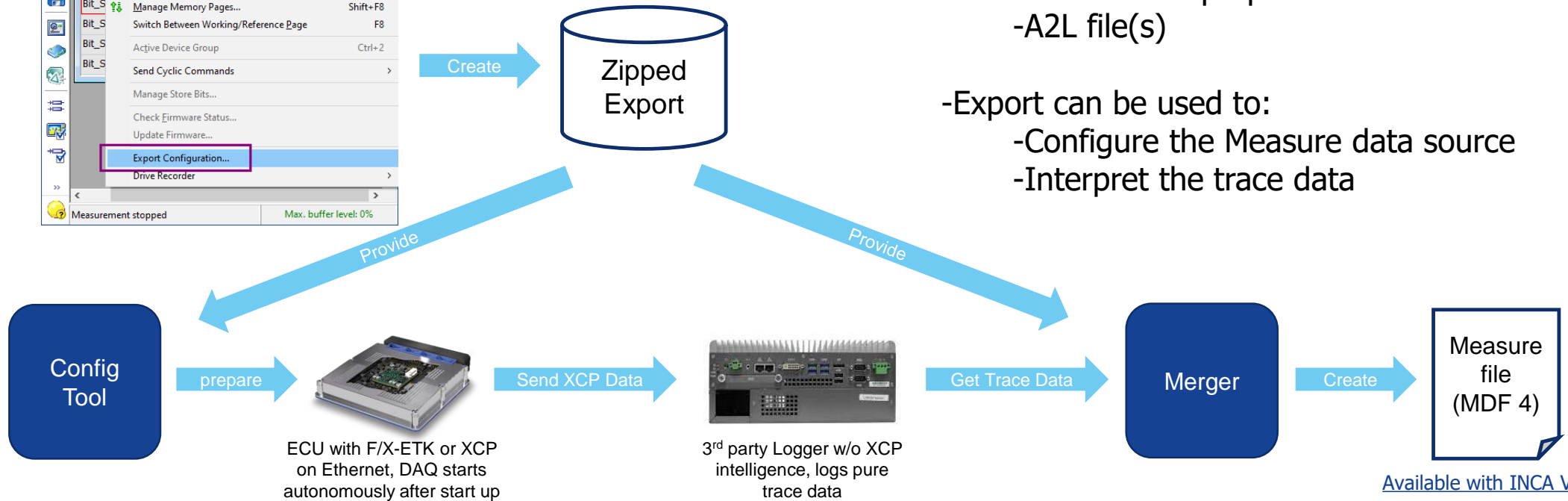
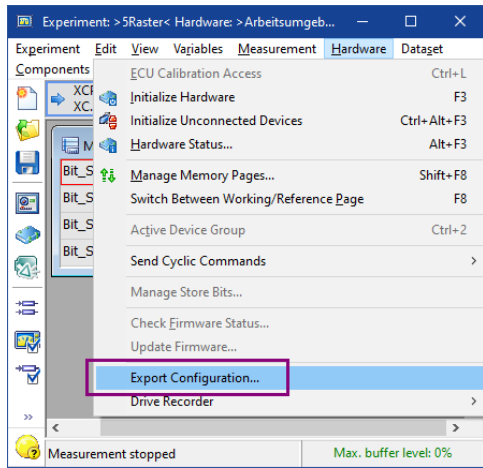

-Export contains:

- Measure Configuration as JSON
- XCP session properties as JSON
- A2L file(s)

-Export can be used to:

- Configure the Measure data source
- Interpret the trace data

Functionality



CAN XL support

CAN XL in a nutshell

1. Increased maximum Payload Length



2. Increased maximum Data Speed

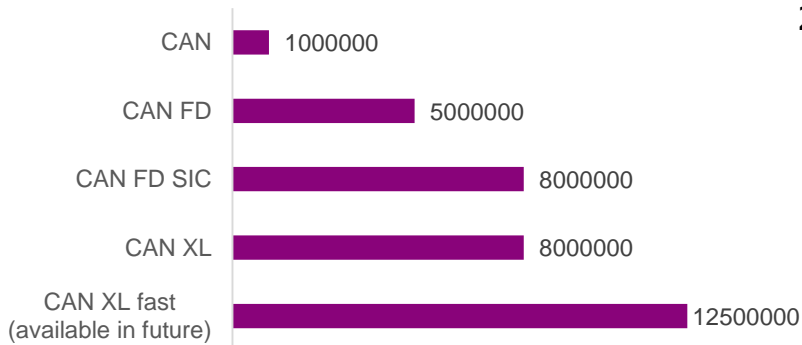

Required components

1. AUTOSAR file with CAN XL description
 - appearance as cluster of type CANXL
 - Minimum version R 22-11

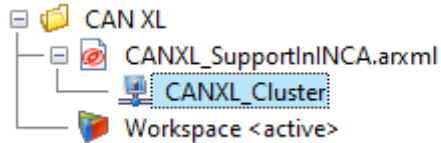

2. ES8xx.2 as CAN XL capable hardware



Additional

1. Reworked and new structured UI
2. All parameters accessible in API

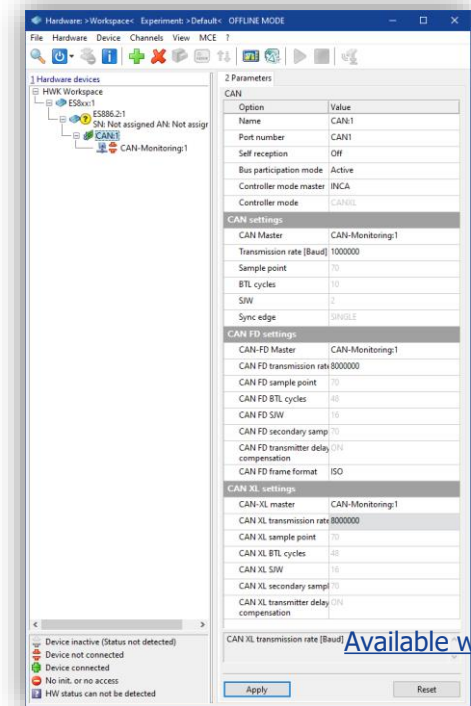

Available with INCA V7.4 SP7

Overview

1. **Product information (Use cases, Sample applications, Customer value)**
 - Performance
 - Functionality
 - **Standards**
 - Usability
 - HW support
 - Add-ons
2. **INCA Product Family**
3. **Phase out information**
4. **General Notes**

INCA V7.4 – What's New

Standards

Autosar – Release 20-11 Support in INCA

- INCA supports the new AUTOSAR schema
- with already supported functionality
- no additional functionality implemented

Standards

Autosar – Release 21-11 Support in INCA

INCA supports now the new Autosar Release 21-11 format.

Note: By this the feature set supported by INCA is not extended

INCA V7.4 – What's New

Functionality

Autosar – LIN support

Additionally to already supported bus types INCA supports now AUTOSAR files for LIN busses.

Each cluster is available as a child node of the description file.

Each LIN-Version supported by INCA can be described in all AUTOSAR versions from 4.1 onwards.

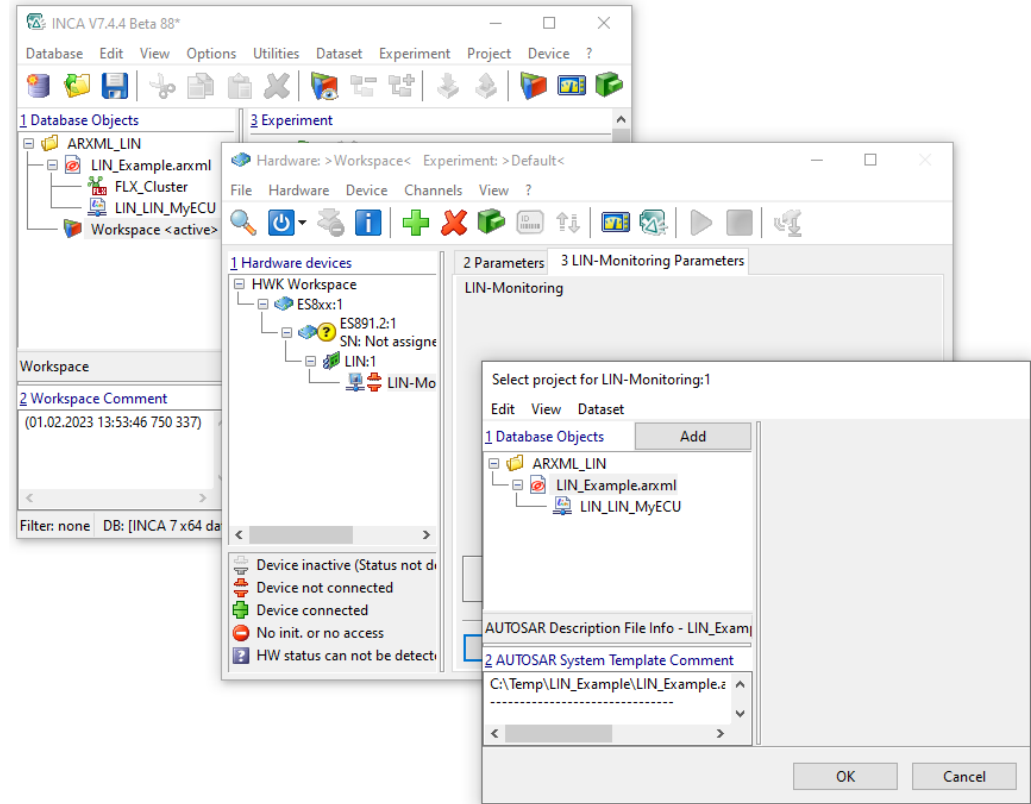

Available with INCA V7.4 SP4

AUTOSAR + Ethernet

AUTOSAR – Extended support of SocketConnectionIpduIdentifier

AUTOSAR offers multiple semantics to describe Socket Adapters (mapping of PDUs to Frames)

The as before supported structure is:

SOCKET-CONNECTION → PDUS → SOCKET-CONNECTION-IPDU-IDENTIFIER

Now additionally the following structure is supported:

SOCKET-CONNECTION-IPDU-IDENTIFIER-SET → I-PDU-IDENTIFIERS → SO-CON-I-PDU-IDENTIFIER

If the same PDU is received multiple times in an Ethernet frame, INCA will add 1 ns time offset to the reception time to satisfy the MDF requirement for strictly increasing time stamps

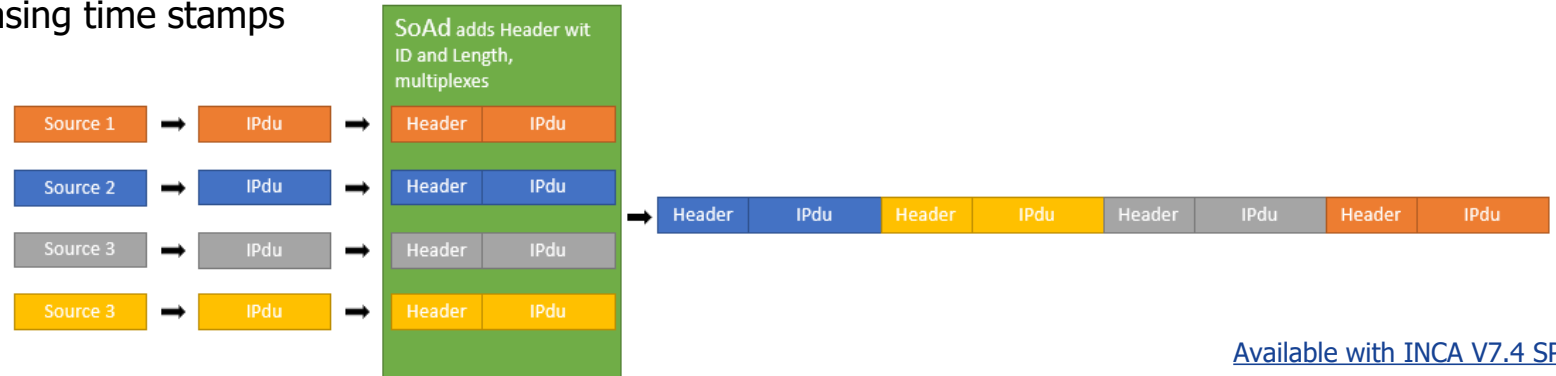

Overview

1. **Product information (Use cases, Sample applications, Customer value)**
 - Performance
 - Functionality
 - Standards
 - **Usability**
 - HW support
 - Add-ons
2. **INCA Product Family**
3. **Phase out information**
4. **General Notes**

Usability

Import – Add Icons to the Import Overview

The importer window shows artefact specific icons.

This helps to get a better overview what to select for import.

Highlight only the artefacts needed

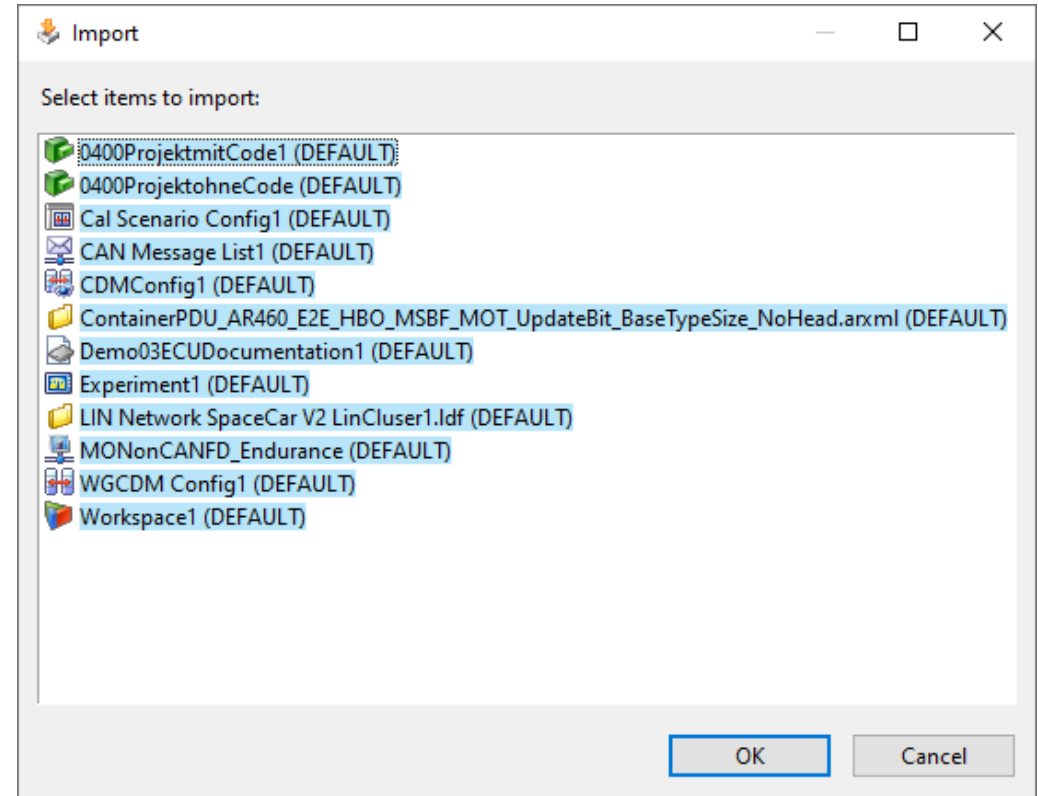

Usability

VSD – Open with the focus on the currently selected widget

Select a widget in the Experiment

Start the Display / Variable Configuration Dialog

The related widget is selected

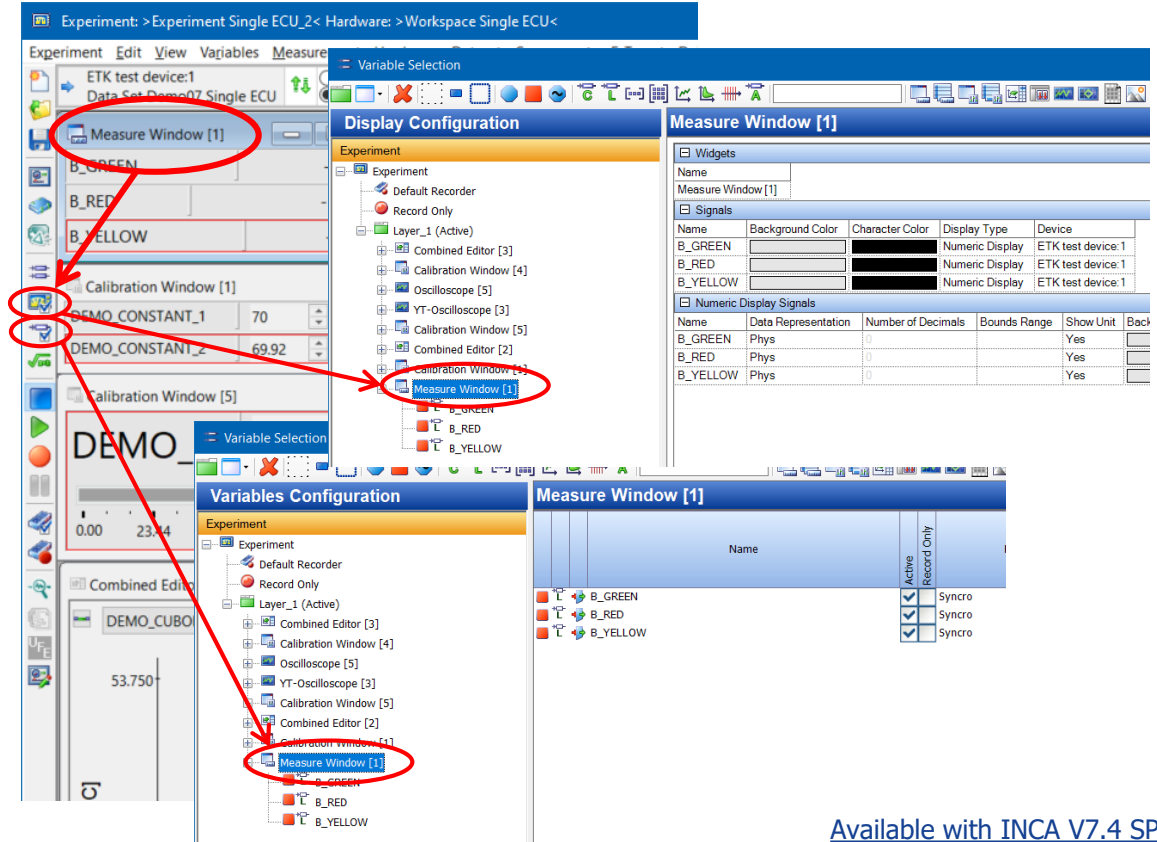

Overview

1. **Product information (Use cases, Sample applications, Customer value)**
 - Performance
 - Functionality
 - Standards
 - Usability
 - **HW support**
 - Add-ons
2. **INCA Product Family**
3. **Phase out information**
4. **General Notes**

INCA V7.4 – What's New

Hardware Support

Vector VX1161 Integration in INCA

Supported device types:

- VX1161.41A (CAN FD)
- VX1161.41B (CAN FD + FlexRay)

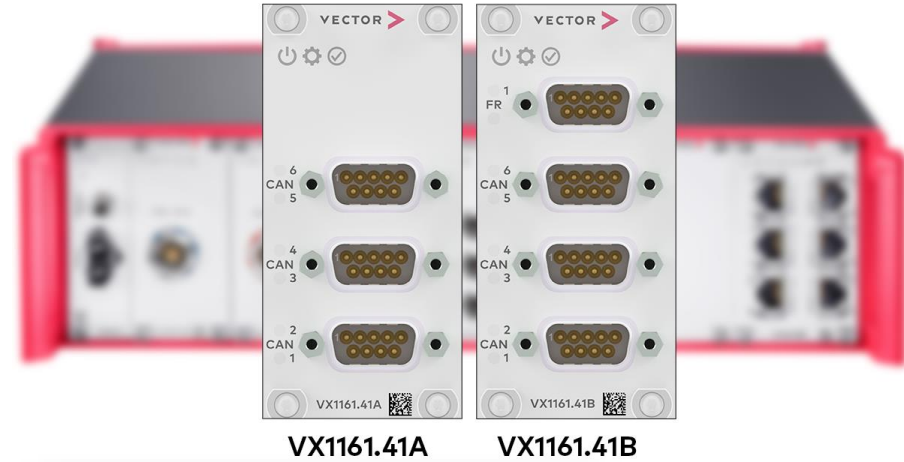

The single piggies are represented as devices since the piggies have individual IP addresses.

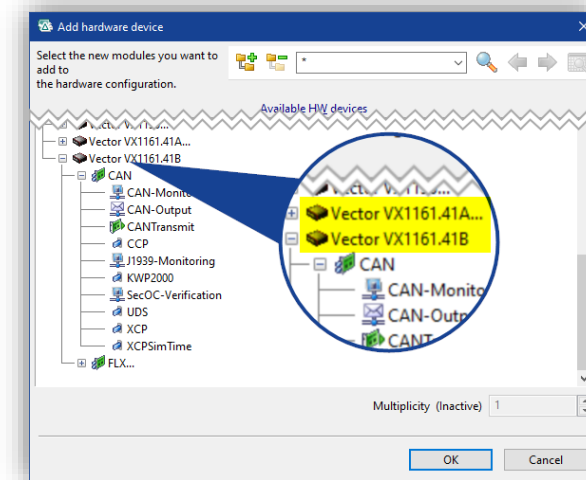

Available with INCA V7.4 SP6

INCA V7.4 – What's New

Hardware Support

VN5650 Support

- 2 x CAN/CAN_FD ports
- A valid Subscription SW license is required
- Enable bit not supported for this device
- Ethernet and USB Host port supported

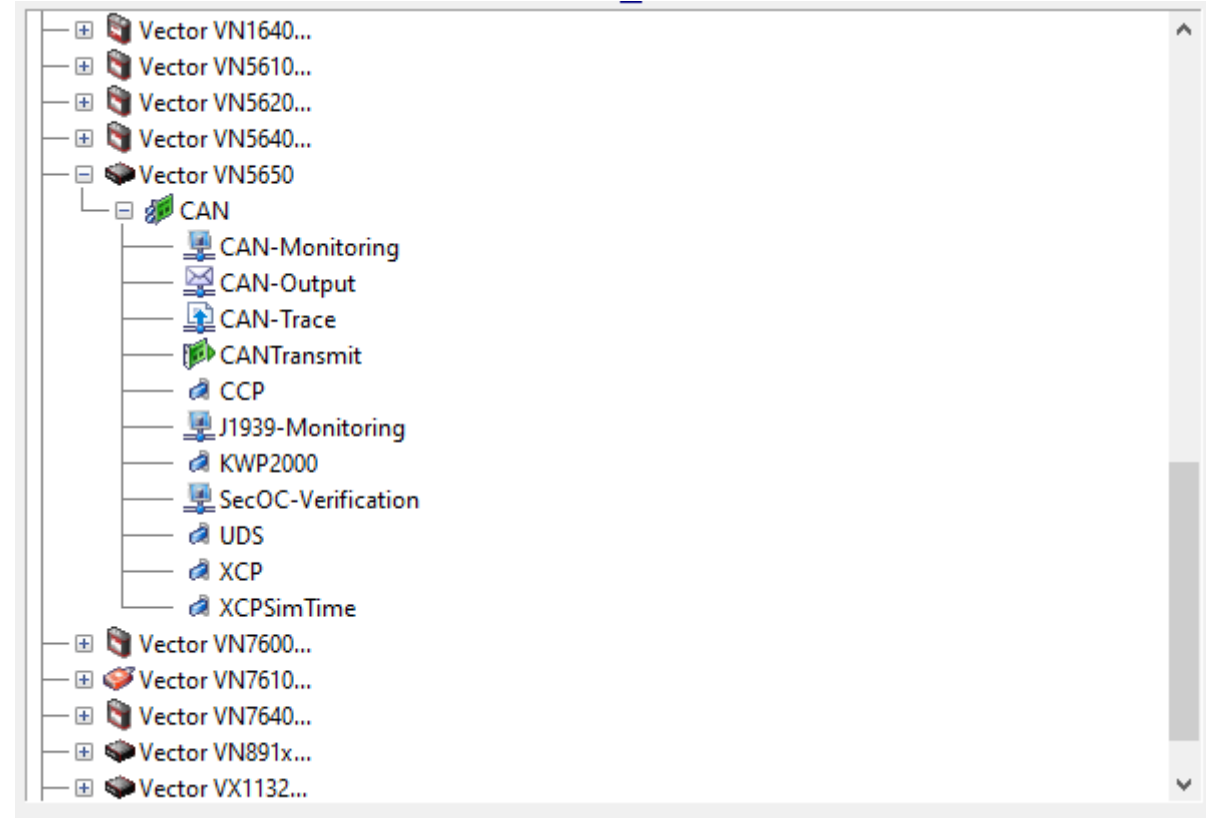

INCA V7.4 – What's New

Hardware Support

VN5430 – Support of Ethernet

VN5611/VN5612 – Support of Ethernet

- Vector devices using the Network-Based Mode are visualized as Vector Ethernet Network in INCA.
- Supported Vector devices for the Vector Ethernet Network system in INCA:
 - VN5240, VN5430, VN5610(A), VN5611, VN5612, VN5620, VN5640, VN5650
- A valid Subscription SW license is required

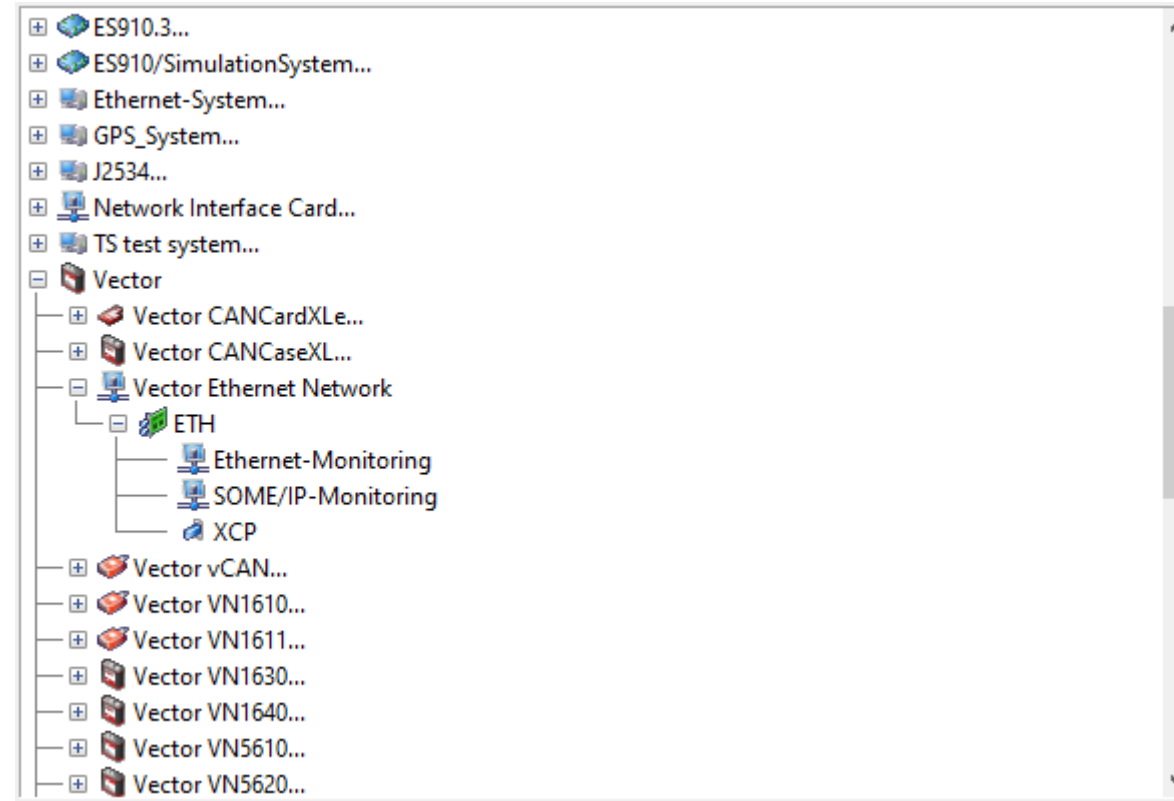

INCA V7.4 – What's New

Hardware Support

Vector VN1670

- 5x build-in CAN/CAN_FD ports
- 5x build-in LIN ports
- 5x optional piggies (CAN/CAN_FD or LIN or CAN-XL in future)
- A valid subscription SW license is required
- Enable bit is not supported for this device
- Ethernet and USB Host port are supported

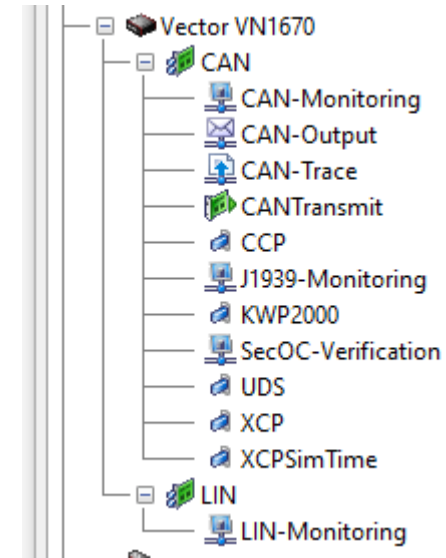

Hardware Support

CAN-FD – Support up to 8 MBaud for Vector Devices

INCA offers now the possibility to configure 8 Mbaud for CAN-FD Controller of Vector devices.

Supported devices:

VN1610, VN1611, VN1630, VN1640, VN1670, VN5610, VN5620, VN5640, VN5650, VN7610, VN7640, VN8970, VN8972, VX1132, VX1135 and vCAN

Hardware Support

ES882.2, ES891.2 and ES892.2 – Support of 8MBaud

- Integration of new HW devices ES882.2, ES891.2 and ES892.2
- Supporting 8MBaud data transfer rate for CAN-FD

Hardware Support

Support 800/3200 KBaud for ES8xx

- ES891, ES892, ES882, ES886 and ES886.2 are now offering the CAN-FD baudrate combination of 800/3200 KBaud

The screenshot shows the INCA software interface. On the left, a tree view under '1 Hardware devices' shows a workspace 'HWK Workspace_66' containing an 'ES8xx:1' device. Underneath, 'ES886.2:1' is expanded to show 'CAN:3' and 'CAN-Monitoring:1'. On the right, the '2 Parameters' window is open, displaying a table of CAN parameters. A blue arrow points from the 'Transmission rate [Baud]' field (set to 800000) to the 'CAN FD Master' field (set to CAN-Monitoring:1). Another blue arrow points from the 'CAN FD Master' field to the 'Data transmission rate [Baud]' field (set to 3200000).

Option	Value
Name	CAN:3
Port number	CAN1
CAN Master	CAN-Monitoring:1
Transmission rate [Baud]	800000
Sample point	70
BTL cycles	10
SIW	2
Sync edge	SINGLE
Bus participation mode	Active
Self reception	Off
CAN-FD Master	CAN-Monitoring:1
Data transmission rate [Baud]	3200000
CAN FD Sample point	70
CAN FD BTL cycles	48
CAN FD SIW	16
CAN FD Secondary sample p	70
CAN FD Transceiver delay compensation	ON
CAN FD Frame format	ISO

INCA V7.4 – What's New

Hardware Support

ES132 – Integration in INCA – CAN / CAN-FD to Ethernet

Adds 2 High-Speed CAN-FD channels to an ETAS Hardware Set-Up

- FE coded Lemo connector for connection to ES8xx, ES5xx and ES600.2 devices
- Power and communication over the Ethernet Host cable
- Supports ETAS time synchronization mechanism
- Supports the ETAS wake up – sleep mechanism
- Multi-Client Support

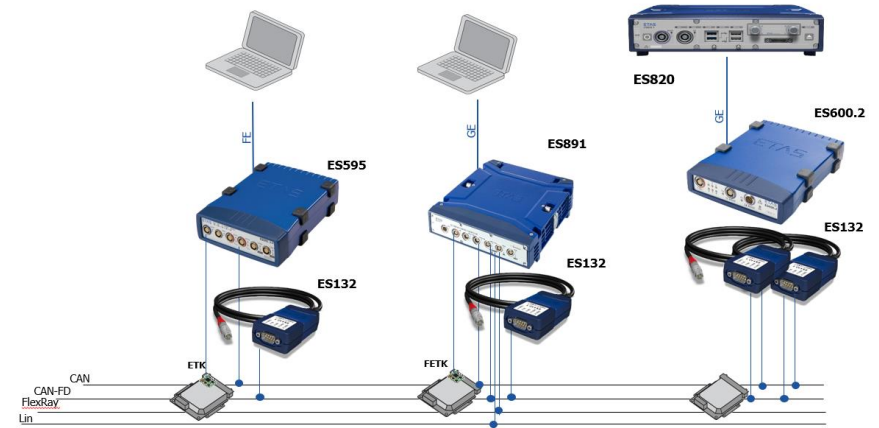

Available with INCA V7.4 SP2

Overview

1. **Product information (Use cases, Sample applications, Customer value)**
 - Performance
 - Functionality
 - Standards
 - Usability
 - HW support
 - **Add-ons**
2. **INCA Product Family**
3. **Phase out information**
4. **General Notes**

INCA V7.4 – What's New

Add-ons

MATLAB – Support of MATLAB 2022A

– INCA-SIP & INCA-MIP

INCA V7.4 – What's New

Add-ons

MATLAB – Support of MATLAB 2022B

– INCA-SIP & INCA-MIP

INCA V7.4 – What's New

Add-ons

MATLAB – Support of MATLAB 2023A

– INCA-SIP & INCA-MIP

INCA V7.4 – What's New

Add-ons

MATLAB – Support of MATLAB 2023B

– INCA-SIP & INCA-MIP

Add-ons

SIP – MDF write – Basic GUI

- To enable an easier usage of the MDF-write functionality, INCA-SIP has introduced a GUI option.
- With this GUI option, it is now possible to export MDF-files directly out of Simulink® using signal logging.

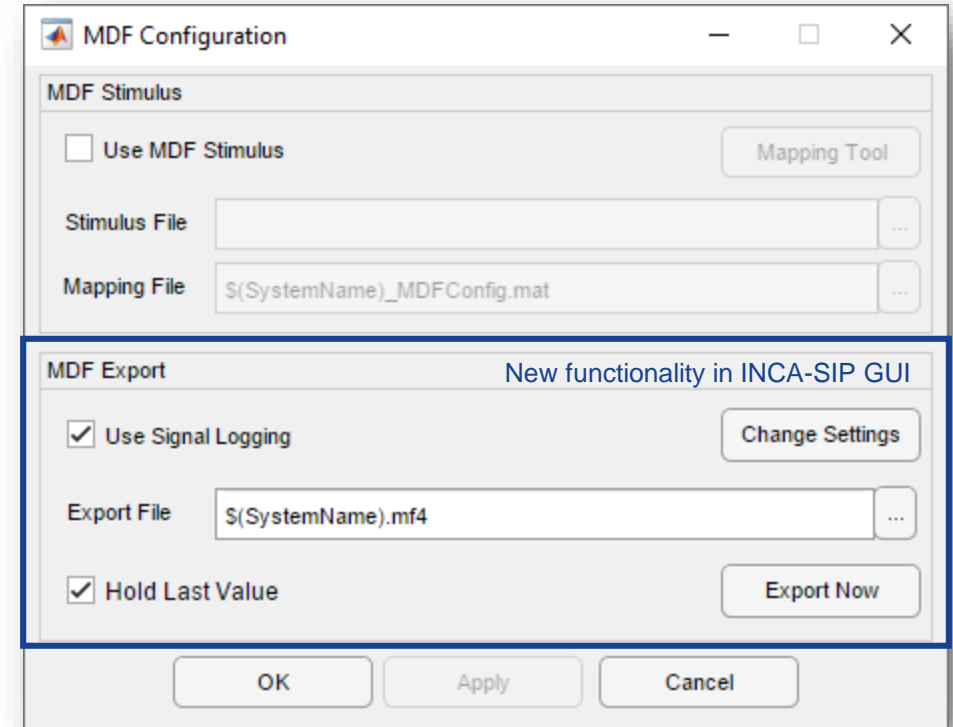

Add-ons

SIP – Advanced GUI for "MDF Write"

- Allows the configuration and setup of automatic MDF Export on 'Stop' Simulation callback
- Supports export file auto-increment to prevent file name collision
- Overwrites previous created export file when auto-increment is disabled
- Appends additional '_xx' when counter resets due to new session or change in file name
- Auto-increment can also be used by the 'Export' button to prevent file name collision

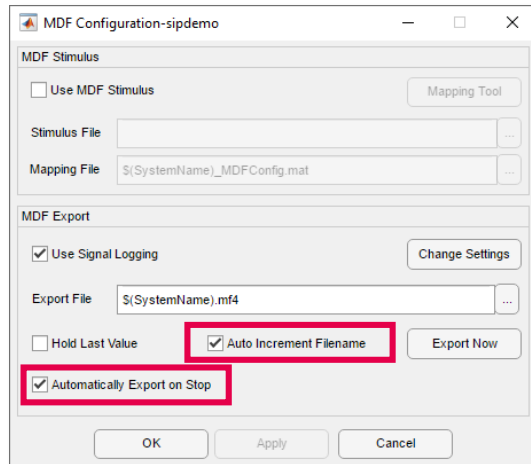

sipdemo_01.mf4	26/10/2022 10:54	MF4 File	4 KB
sipdemo_02.mf4	26/10/2022 10:54	MF4 File	4 KB
sipdemo_03.mf4	26/10/2022 10:56	MF4 File	4 KB

Available with INCA V7.4 SP3

Add-ons

SIP – Support of Shared Configurations

- Each Simulink® model has a configuration acting as its model specific settings
- Simulink® also supports using external configuration sets, which are not tied to a model. Such shared configurations can be activated for a particular model. Changes in this configuration might affect multiple models
- Now INCA-SIP supports these types of configurations. By a specific new syntax SIP allows to automatically modify settings to use the configurations

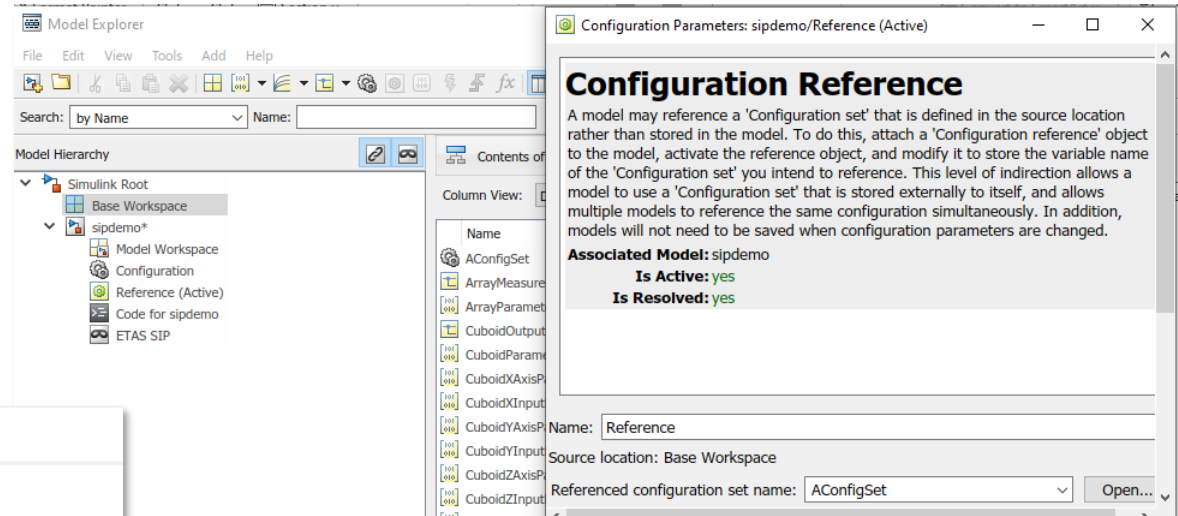
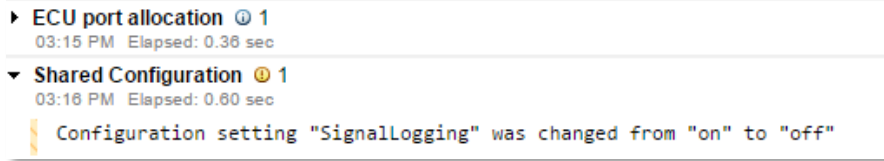

Add-ons

MCE – iLinkRT V3 – Sending Measurement Data by Unicast

The iLinkRT V3 standard defines two ways for measurement data transfer

Multicast Sending

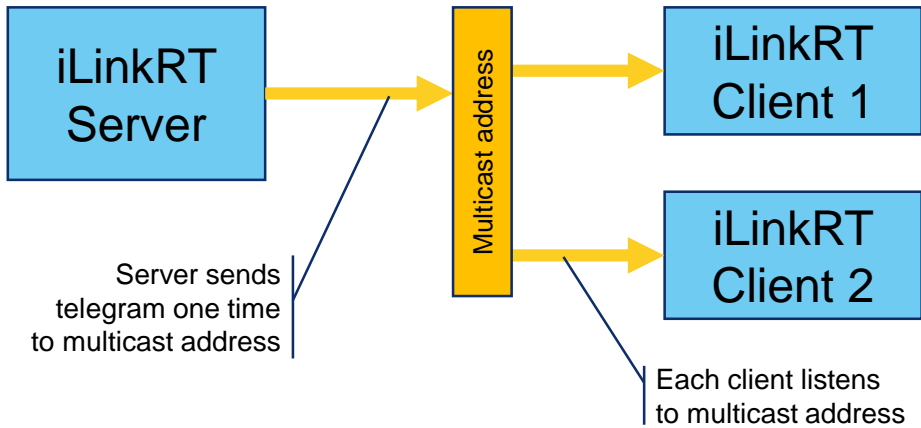

Advantage Multicast

- Better performance on server side
- All clients are informed at the same time

Unicast Sending

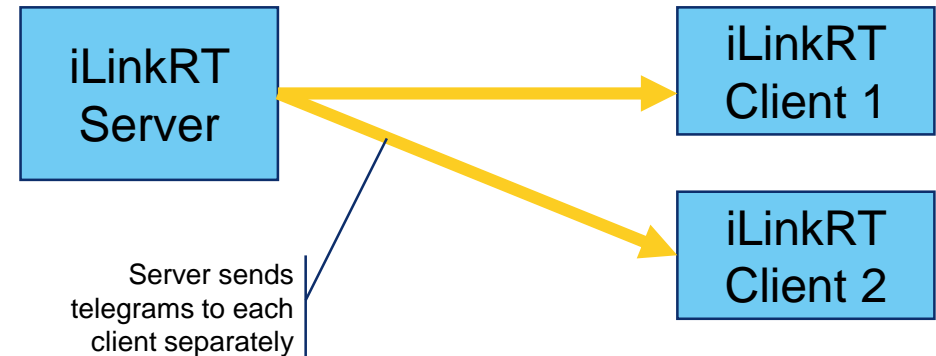

Advantage Unicast

- No special router config needed (Multicast is blocked often)

Add-ons

MCE – iLinkRT V3 - Add Key Value Pairs to MDF Recorder File

Additional info can be added to the recorder file while recorder is running or paused

Byte [#]	Description	Type	Value
0	Data array size	A_UINT16	133
8	Command	A_UINT16	0x0600 - RT3 ADD KEY VALUE PAIR TO RECORDER FILE
10	Device ID	A_UINT16	0
12	Tree path	RT_STRING	<tree name="TestBench7"><tree name="TestResults"></tree></tree>
78	Count of Key Value Pairs	A_UINT8	2
79	Key	RT_STRING	<e name="Test1"></e>
102	Value	RT_STRING	OK
107	Key	RT_STRING	<e name="Test2"></e>
130	Value	RT_STRING	Error_21

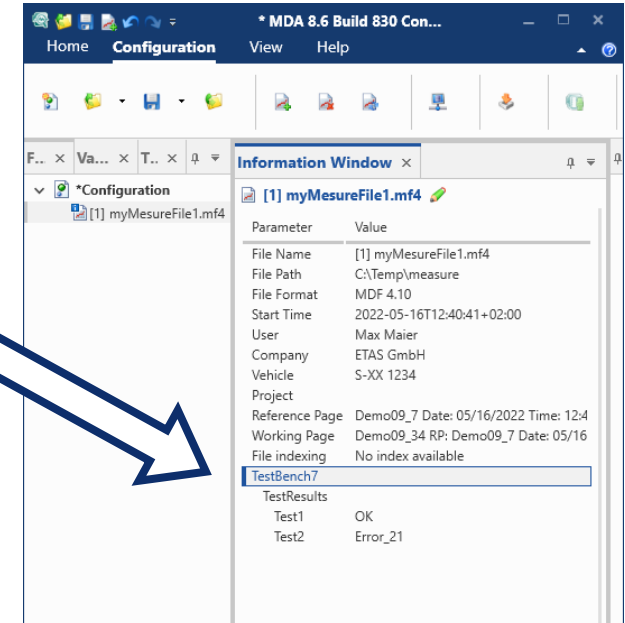
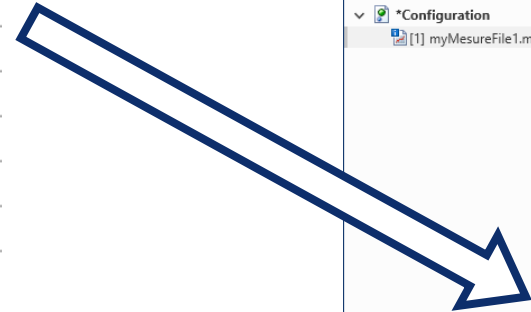

INCA V7.4 – What's New

Add-ons

MCE – iLinkRT V3.0 - IPv6

INCA-MCE supports now beside IPv4 additionally IPv6 networks.

Switch to IPv6

Use IPv6 addresses

Establish Connection

How can you establish connection to the Automation System?

RS232 / V.24 connection ("Serial")

Port: COM2 Baud rate: 9600

Network Connection

Network Card: Software Loopback Interface 1

Local Network Address:

Network Adapter / Commands

Use IPv6

Local Network IPv4 Address: 127.0.0.1
(IPv4 Address or zero for system provided IP Address)

Local Network IPv6 Address: fe80::c403:a8ff:fe2e1b%11
(IPv6 Address or zero for system provided IP Address)

ASAP3 Specific

Network Port: 22222 (0-65535)

Use fast socket communication

iLinkRT Get All Server

iLinkRT Version: v3.0

iLinkRT Broadcast Command IPv6 Address: FF02::1
(e. g. multicast ip FF02:1)

iLinkRT Broadcast Command Port: 8090 (0-65535)

iLinkRT Unicast Command Port: 8091 (0-65535)

Available with INCA V7.4 SP3

Add-ons

ODX – Updated OBD and WWH-OBD ODX Projects according to SAEJ1979-DA 2021-04:

Mode 1 and 2: New PIDs \$B1 - \$C5, \$F500-\$F501 (WWH-OBD) and changes to PIDs \$01, \$1C, \$41, \$51

Mode 6: New Unit and Scaling IDs \$45, \$46, \$AB, \$B2, \$B3

Mode 9: New InfoType \$79 and changes to InfoTypes \$0A, \$10, \$50

- All new Mode 1 and Mode 2 PIDs and Mode 9 InfoTypes are available as Measurement Signals in the Variable Selection Dialog
- The OBD Window displays all new data when used with the new ODX project

The new ODX projects get installed with the INCA-ODX Addon into the folder ETASData\ODX7.4\Projects:

- OBDOnCAN_ETAS_SAEJ1979_2021-04.pdx
- WWH_OBD_ETAS_SAEJ1979_2021-04.pdx
- To use the new functionality, the new ODX projects have to be imported into INCA and assigned to a Workspace with an OBDOnCAN device (or UDS device for WWH-OBD)

Add-ons

ODX – Support of OBDonUDS

- The INCA-ODX AddOn now supports the new OBDonUDS standard according to SAE J1979-2 as of 2021-04
 - New OBDonUDS protocol device in INCA HWC that supports the physical OBDonUDS protocol communication according to SAE J1979-2 and ISO15765-4
 - HWC “Search for OBD ECUs” has been enhanced to automatically detect all connected ECUs supporting OBDonCAN (old SAE J1979) or OBDonUDS (new SAE J1979-2) and automatically configure the HWC OBD devices accordingly
 - New ODX project “OBDonUDS_ETAS_SAEJ1979-2_2021-04.pdx” for requesting all OBDonUDS data according to SAE J1979-2 with ODX-LINK windows and to measure and record OBDonUDS data with INCA (e.g. PIDs, ITIDs)

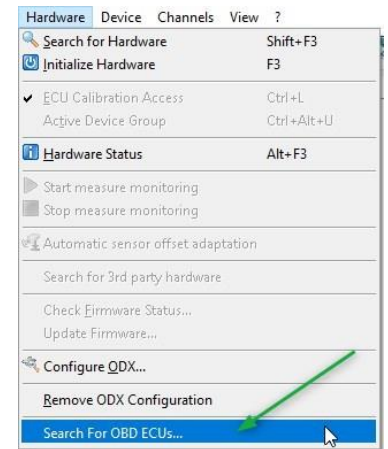
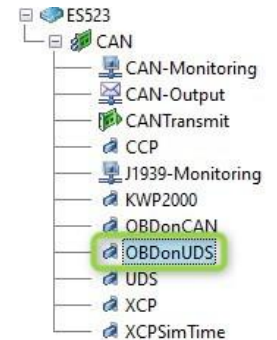

Add-ons

ODX – ODX Project for SAEJ1979-2 (OBDonUDS)

– The new ODX project “OBDonUDS_ETAS_SAEJ1979-2_2021-04.pdx” contains all OBDonUDS services according to SAE J1979-2 and SAE J1979-DA as of 2021-04

- Request Current Powertrain Diagnostic Data (Service \$22 reading PIDs)
- Request Vehicle Information (Service \$22 reading InfoType IDs, ITIDs)
- Request On-Board Monitoring Test Results for Specific Monitored Systems (Service \$22 reading MIDs)
- Clear/Reset Emission-Related Diagnostic Information (Service \$14)
- Request Emission-Related Diagnostic Trouble Codes with Confirmed Status (Service \$19 - Subfunction \$42)
- Request Emission-Related Diagnostic Trouble Codes with Pending Status (Service \$19 - Subfunction \$42)
- Request Emission-Related Diagnostic Trouble Codes with Permanent Status (Service \$19 - Subfunction \$55)
- Request Powertrain Freeze Frame Data (Service \$19 - Subfunction \$04)
- Request Supported DTCExtendedRecord Information (Service \$19 - Subfunction \$1A)
- Request DTCExtendedDataRecord (Service \$19 - Subfunction \$06)
- Request DTCs for a ReadinessGroup (Service \$19 - Subfunction \$56)
- Request Control of On-Board System, Test, or Component (Service \$31)

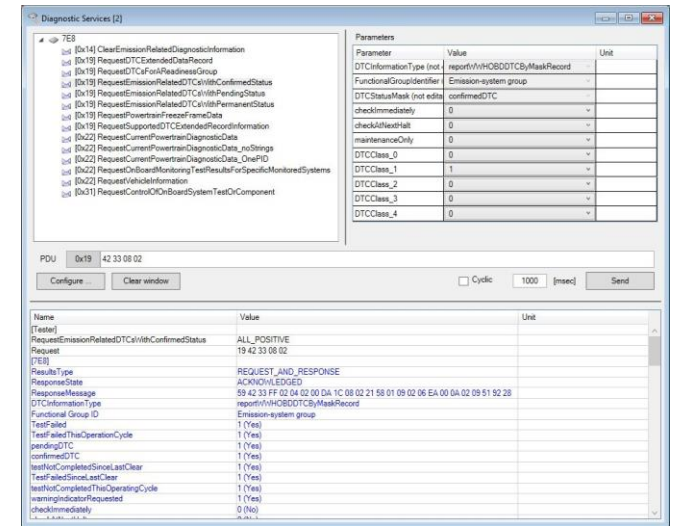

– The new OBDonUDS ODX project can be used with the Diagnostic Services, Service Inspector and Hex Services windows of ODX-LINK (OBDonUDS window support will be added later)

– PID, ITID and DTC measurement signals are available in the VSD for measurement and recording with INCA

Available with INCA V7.4 SP2

Add-ons

ODX – OBD GUI support for OBDOnUDS (SAE J1979-2)

The INCA-ODX Add-on supports the new OBDOnUDS standard according to SAE J1979-2 since INCA V7.4-SP2 by providing a new OBDOnUDS device in INCA HWC and a new ODX file for OBDOnUDS.

Starting with INCA 7.4-SP4 the OBD GUI now also supports OBDOnUDS for the following data and services:

- Vehicle Information data (Service \$22 InfoType IDs/ITIDs)
- Current Powertrain Diagnostic Data (Service \$22 PIDs)
- On-Board Monitoring Test Results for Specific Monitored Systems (Service \$22 MIDs)
- Emission-Related Diagnostic Trouble Codes with Confirmed Status (Service \$19 - Subfunction \$42)
- Emission-Related Diagnostic Trouble Codes with Pending Status (Service \$19 - Subfunction \$42)
- Emission-Related Diagnostic Trouble Codes with Permanent Status (Service \$19 - Subfunction \$55)
- Clear/Reset Emission-Related Diagnostic Information (Service \$14)

Further OBDOnUDS data and services will be supported by the OBD GUI in a future SP update.

Add-ons

ODX – OBD GUI support for OBDonUDS (SAE J1979-2) and ZEVonUDS (SAE J1979-3)

The OBD GUI now fully supports all OBDonUDS and ZEVonUDS data and services:

- Vehicle Information data (Service \$22 InfoType IDs/ITIDs)
- Current Powertrain Diagnostic Data (Service \$22 PIDs)
- On-Board Monitoring Test Results for Specific Monitored Systems (Service \$22 MIDs)
- Emission-Related Diagnostic Trouble Codes with Confirmed, Pending and Permanent Status (Service \$19 - Subfunction \$42 and \$55)
- Powertrain Freeze Frame Data (Service \$19 – Subfunction \$04)
- DTC extended Data Records (Service \$19 – Subfunctions \$1A and \$06)
- DTCs for Readiness Groups (Service \$19 – Subfunction \$56)
- Clear/Reset Emission-Related Diagnostic Information (Service \$14)

The OBD GUI can now be used with both:

- the `OBDonUDS_ETAS_SAEJ1979-2_2021-04.pdx` project for OBDonUDS and ZEVonUDS or
- the `OBDonCAN_ETAS_SAEJ1979_2021-04.pdx` project for OBDonCAN

Furthermore, all OBD GUI settings are now saved as part of the Experiment configuration.

Add-ons

ODX – Updated OBDonCAN and OBDonUDS ODX projects supporting SAEJ1979-DA 2022-03

OBDonCAN:

- New mode 1 and mode 2 PIDs \$C6-\$CD and changes to PIDs \$1C, \$73, \$A3 and \$AC
- New mode 9 InfoTypes \$2A, \$80-\$84 and changes to \$0A and \$74

OBDonUDS:

- New Service \$22 PIDs \$F4C6-\$F4CD, \$F502-\$F505 and changes to \$F41C, \$F473, \$F4A3 and \$F4AC
- New Service \$22 InfoTypes \$F82A, \$F880-\$F884 and changes to \$F80A and \$F874

All new PID and InfoType response parameters are available as measurement signals in the Variable Selection Dialog for polling measurement and recording with INCA

The OBD Window displays all new and changed data when using it with the new ODX projects

The new ODX projects get installed with the INCA-ODX Addon into ETASData\ODX7.4\Projects:

- OBDonCAN_ETAS_SAEJ1979_2022-03.pdx
- OBDonUDS_ETAS_SAEJ1979-2_2022-03.pdx

To use the new functionality the new ODX projects have to be imported into INCA and assigned to a Workspace with an OBDonCAN or OBDonUDS device.

Add-ons

EIP – Offline Calibration

Setups using INCA-EIP can be calibrated offline now. This works now without rapid prototyping hardware running and connected. In order to use offline calibration, INCA needs the initial data set

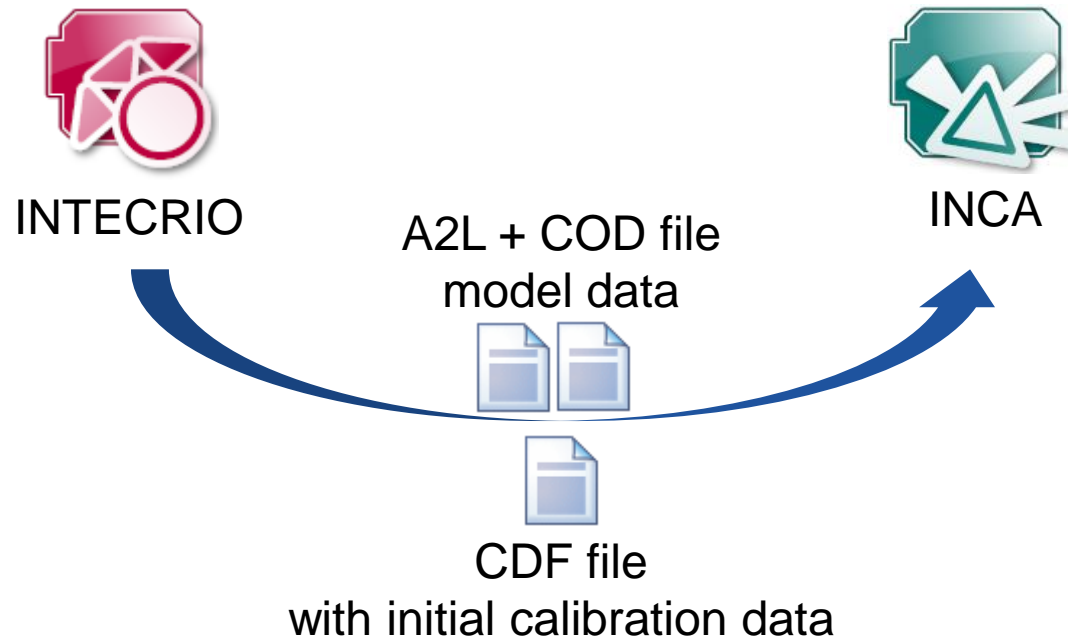

Add-ons

EIP – Offer Data-Freeze in case E-TARGET WP should be flashed

Flashing an E-Target working page dataset results typically in different checksum on reference page. INCA now offers an option to define the INCA internal behavior for the data set handling. The user can define the default behavior in the user options.

- Option set to no: the old known behavior
- Option set to yes: INCA uses the current WP as new RP and creates a copy to be used as WP dataset

The screenshot shows the INCA software interface. On the left, a tree view under 'HWC:' shows 'Hardware devices' expanded to 'HWK Workspace', which contains 'ES910.3:1' (with a warning icon and 'SN: Not assigned AN: No') and 'ES910/Simulation Controller'. On the right, the 'Parameters' tab is active for 'ES910/Simulation Controller'. A table lists various options and their values. Two options are highlighted with green boxes: 'Automatic freeze after flashing WP' (set to 'No') and 'Perform an automatic freeze after flashing WP' (set to 'Yes').

Option	Value
Name	ES910/Simulation Controller:1
Meas. failure behavior	Abort after failure
Start after Initialization	No
Automatic upload to dataset	Yes
Automatic freeze after flashing WP	No
Project working data	
Reference Data	
Perform an automatic freeze after flashing WP	Yes

Available with INCA V7.4 SP1

INCA V7.4 – What's New

Add-ons

INCA Service Pack Installer – Add-on RDE added

INCA Add-on RDE (Real Driving Emissions) is a software which is an assistant that allows test drivers to track the status of real driving emissions measurements in real time. This makes it possible to monitor whether RDE measurements comply with statutory limits.

For more information, please visit:

<https://www.etas.com/en/products/inca-rde.php>

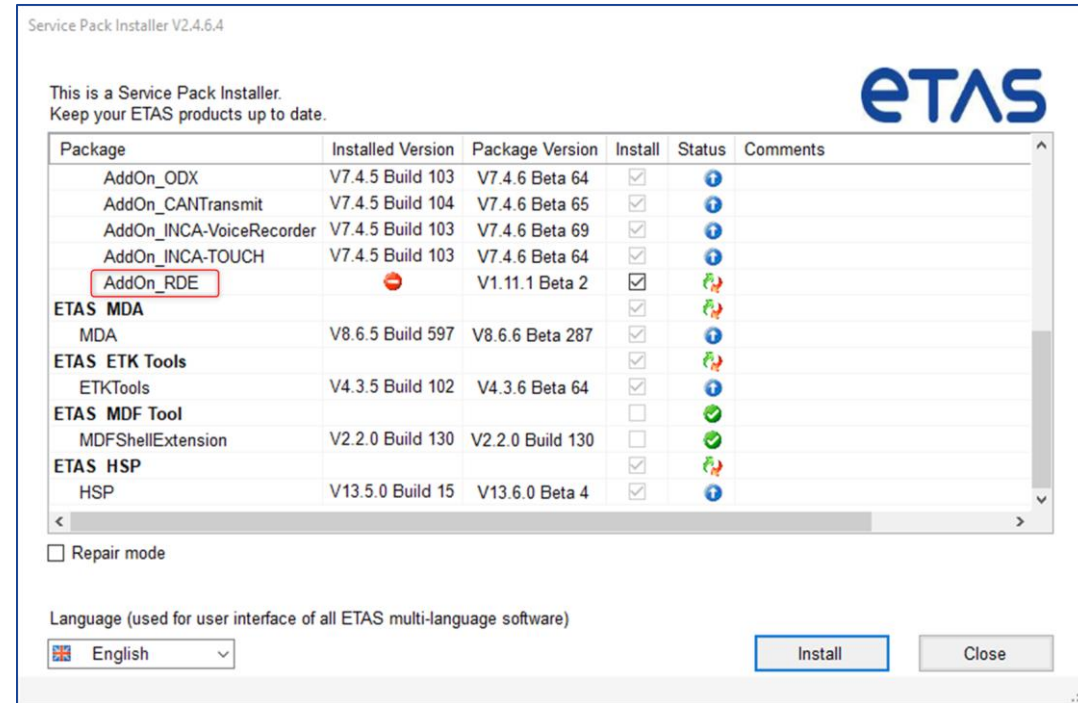

Available with INCA V7.4 SP6

Add-ons

INCA Service Pack Installer – Add-on EV Instruments added

EV Instruments extends the Experiment by an additional instrument specific for battery.

It enables you to detect easily battery cells with temperatures outside the expected range.

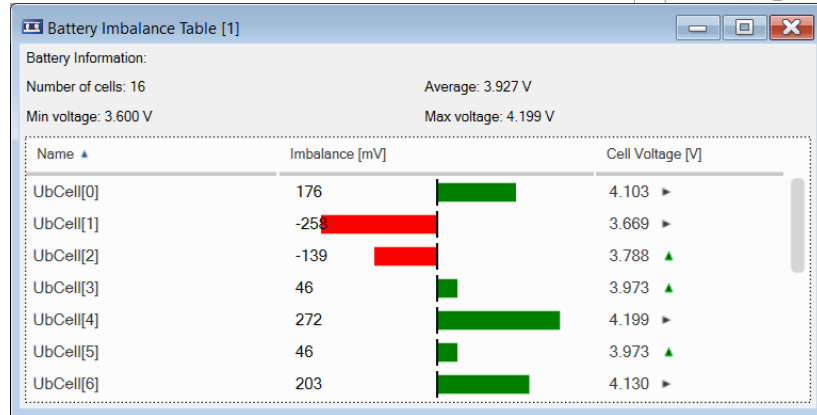

This is a Service Pack Installer.
Keep your ETAS products up to date.

Package	Installed Version	Package Version	Install	Status	Comments
ETAS INCA			<input type="checkbox"/>	✓	
INCA	V7.4.6 Beta 87	V7.4.6 Beta 87	<input type="checkbox"/>	✓	
General AddOns (free)			<input type="checkbox"/>		
AddOn_EV-Instruments	V7.4.6 Beta 28	V7.4.6 Beta 28	<input type="checkbox"/>	✓	
AddOn_eCDM	V7.4.6 Beta 75	V7.4.6 Beta 75	<input type="checkbox"/>	✓	
AddOn_DriveRecorder		V7.4.6 Beta 75	<input type="checkbox"/>		
AddOn_Video-Tutorials		V7.4.6 Beta 75	<input type="checkbox"/>		
	V7.4.6 Beta 75	V7.4.6 Beta 75	<input type="checkbox"/>	✓	
		V7.4.6 Beta 75	<input type="checkbox"/>		
		V7.4.6 Beta 76	<input type="checkbox"/>		
		V7.4.6 Beta 75	<input type="checkbox"/>		

Install Close

Add-ons

INCA Service Pack Installer – AddOn CAN-Trace added

If there are issues on the bus, monitoring dedicated signals on a bus is often not sufficient to find the cause.

It's often needed to have a trace of the complete bus communication to be able to analyze also signals that were not explicitly monitored.

Service Pack Installer V2.4.2.12

This is a Service Pack Installer.
Please keep your ETAS-Products up to date.

Package

- AddOn_ODX
- AddOn_CANTransmit
- AddOn_CAN-Trace**
- AddOn_INCA-VoiceRecorder
- AddOn_INCA-TOUCH

ETAS MDA

- MDA

ETAS ETK Tools

- ETKTools

ETAS MDF Tool

- MDFShellExtension

ETAS HSP

- HSP HSP

Repair mode
 I read and accept the [end user license](#)

Language (used for user interface of all products)

English

Hardware: >03.02-Test-WS< Experiment: >03.02-Test-Exp<

1 HW-Geräte

- HWK 03.02-Test-WS
 - ES582.1:1
 - SN: 100002 AN: Nicht zugewiesen
 - CAN:1
 - CAN-Monitoring:1
 - CAN-Trace:1**

2 Parameter 3 CAN-Trace Parameter

CAN-Trace

- CAN-Trace Directory C:\Tmp\Trace\Test-03.2
- CAN-Trace File Trace
- CAN-Trace Format ascii
- Configure CAN-Type Autoconfigure**
- Tracing period Only while recording
- CAN Parameters
- CAN-FD Parameters

Measure Table [3]

CANFDFrameCounter\CAN-Trace	- [CANFD_Frames]
CANFrameCounter\CAN-Trace	- [CAN_Frames]
ErrorFrameCounter\CAN-Trace	- [ErrorFrames]
FrameCounter\CAN-Trace	- [Frames]
TracefileIndex\CAN-Trace	- []

Available with INCA V7.4 SP7

Add-ons

SOME/IP Service Discovery for Measurement

INCA goes **AUTOSAR Adaptive!**

- SOME/IP-MC device and corresponding AUTOSAR cluster type
- INCA is actively communicating with ECU using **SOME/IP Service Discovery**
- Support of AUTOSAR adaptive description files R22-11 as well as AUTOSAR classic files
- Available as Add-On "INCA-SOMEIP-MC" (INCA Add-On for Measurement and Calibration via SOME/IP)
- Separate license needed

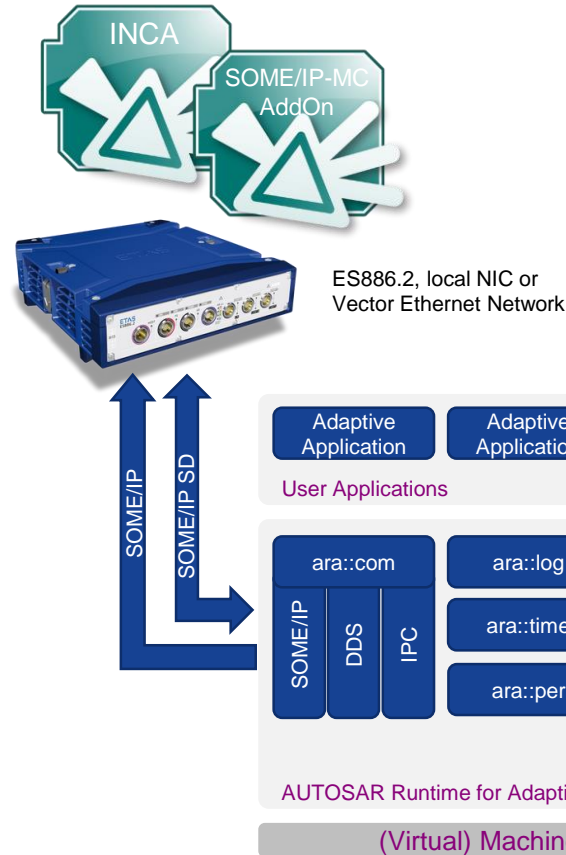

Available with INCA V7.4 SP7

Overview

1. Product information (Use cases, Sample applications, Customer value)

- Performance
- Functionality
- Standards
- Usability
- HW support
- Add-ons

2. INCA Product Family

3. Phase out information

4. General Notes

ETAS License Manager – Announcement of License Server Update

The following information is relevant for customers using floating or user based licenses. Machine based licenses are not affected.

- The components used for the FlexNet Publisher (FNP) license server will be updated to
 - FNP V11.19.4.1
- This version supports Windows Server 2022 and Windows 11
- Contains important bug fixes and addresses known security vulnerabilities

ETAS products released after end of march 2024 require the new ETAS License Server

The software package can be found on [ETAS download center](#)

Please plan to update the ETAS License Server!

INCA Product Family

ETAS License Manager - Migration Wizard for new License Technology

ETAS switches from FlexNet Publisher (FNP) to FlexNet Embedded (FNE) license technology.

The first step was done by introducing the new technology for **machine based** licenses:

- INCA 7.3 accepts both FNE licenses and FNP licenses.
- INCA 7.4 accepts FNE licenses only

To assist you with this, ETAS License Manager offers a wizard which migrates your machine based FNP licenses to FNE licenses.

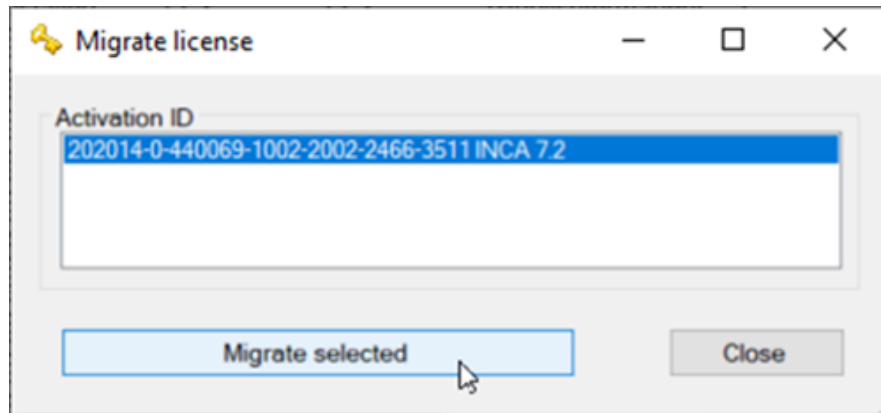

Note:

- ETAS License Manager > 1.8.2 and a valid service contract are required
- New bought machine based INCA licenses are automatically based on FlexNet Embedded.
- User based or Floating licenses are still based on FlexNet Publisher. Further information on introducing FNE for these will follow.

For details please see [Time Line](#) and further info in [ETAS License Management FAQ](#)

INCA V7.4 – What's New

INCA Product Family

INCA Service Pack Installer – HSP Update Tool added

To ensure that INCA can use all features of the connected hardware it is necessary that the connected hardware uses the newest firmware.

The HSP (Hardware Service Pack) is now part of the INCA Service Pack Installer

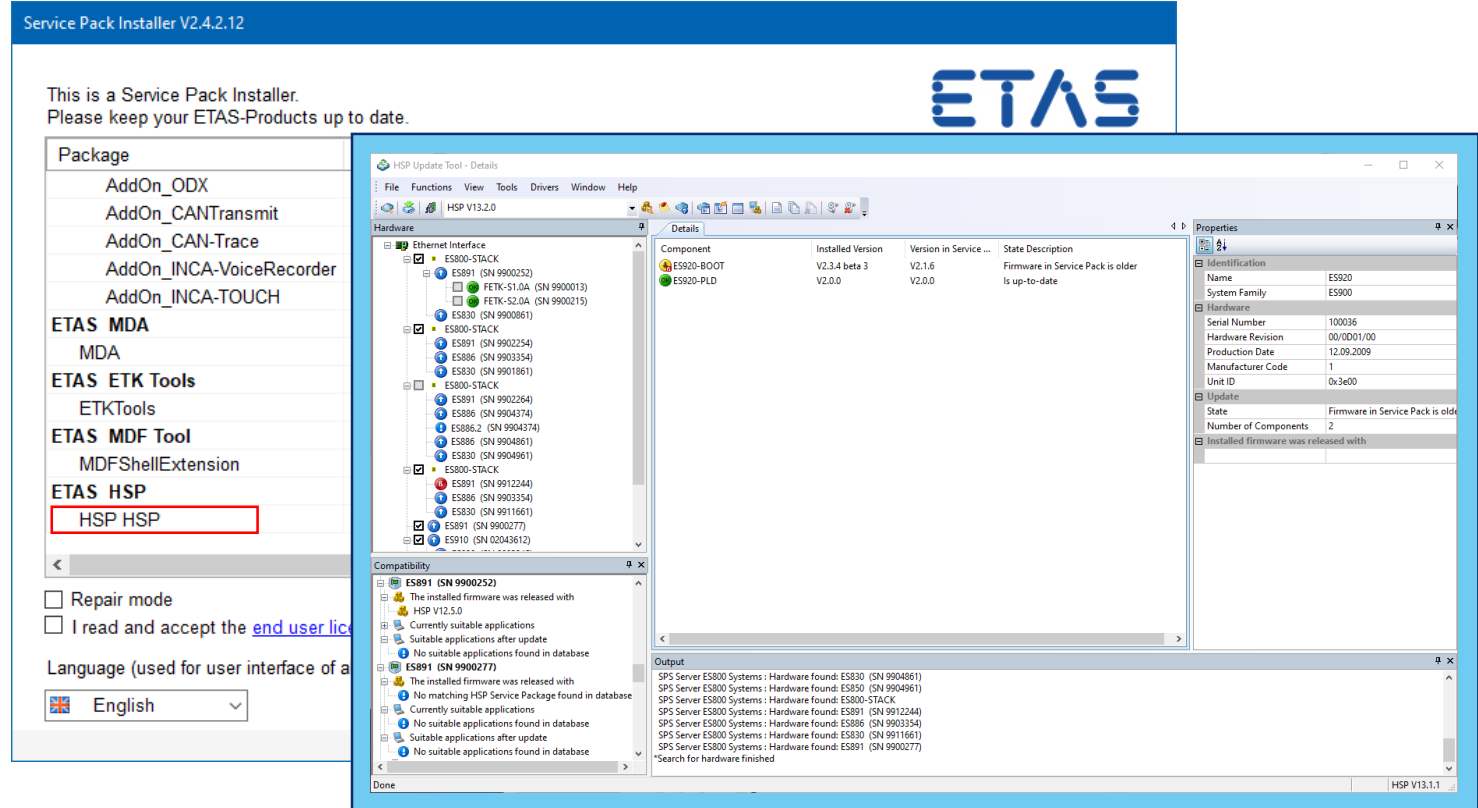

Available with INCA V7.4 SP2

Overview

- 1. Product information (Use cases, Sample applications, Customer value)**
 - Performance
 - Functionality
 - Standards
 - Usability
 - HW support
 - Add-ons
- 2. INCA Product Family**
- 3. Phase out information**
- 4. General Notes**

Announcement concerning "HW Enable Bits"

- The ETAS enable bits functionality for Supported Vector hardware will be phased out
- QA5 Sales stop since Q1/2022
- QA6 Service stop is planned for Q1/2025

For already supported Vector devices and all newly integrated Vector devices INCA supports now a SW license (Machine-Based, User-Based and Floating)!

All Vector devices with active Enable Bit will be supported by INCA at least till QA6 of the hardware.

- INCA checks for the enable bit first
- If no enable bit is available INCA will check for the SW license

Announcement concerning "MATLAB Support"

INCA V7.4 discontinues the support of the following MATLAB versions

- MATLAB 2016A
- MATLAB 2016B
- MATLAB 2017A

Overview

1. **Product information (Use cases, Sample applications, Customer value)**
 - Performance
 - Functionality
 - Standards
 - Usability
 - HW support
 - Add-ons
2. **INCA Product Family**
3. **Phase out information**
4. **General Notes**

INCA V7.4 – What's New

Overview of Functionality added by Service Packs

Links to Functionality Description of Service Pack 1

- [HWC – Support VX Configuration File upload to VX Device](#)
- [HWC – Make Ethernet Filter Setting configurable](#)
- [VLAN – Local-NIC Support in INCA](#)
- [Flexray – Enhanced FLX Start Up Node Configuration](#)
- [ProF – Support Functional Addressing for UDS on CAN/CAN-FD](#)
- [XCP VLAN, IPv4/IPv6 tagged Communication via ES886.2](#)
- [XCP VLAN, IPv4/IPv6 tagged Communication via Vector Hardware](#)
- [XCP VLAN – Use XCP Transport Layer Instance as Configuration Input for VLAN and IP Settings](#)
- [COM-API – Add Key Value Pairs to MDF Recorder File](#)
- [COM-API – Reset Parameter to RP](#)
- [Vector VN1670](#)
- [CAN-FD – Support up to 8 MBaud for Vector Devices](#)
- [MCE – iLinkRT V3 - Add Key Value Pairs to MDF Recorder File](#)
- [ODX – Updated OBD and WWH-OBD ODX Projects according to SAEJ1979-DA 2021-04](#)
- [EIP – Offer Data-Freeze in case E-TARGET WP should be flashed](#)
- [Support 800/3200 KBaud for ES8xx](#)

INCA V7.4 – What's New

Overview of Functionality added by Service Packs

Links to Functionality Description of Service Pack 2

- [Parallel Hardware Initialization of Devices](#)
- [XCP – OS independent Communication Stack extended by full TCP Support](#)
- [CDM – Grid Editor](#)
- [CDM – List Datasets in Batch Operation](#)
- [VSD – New Document Format in "Export Variables for Excel"](#)
- [ETK Related Features](#)
- [Autosar Release 21-11 Support in INCA](#)
- [Experiment – Improved handling of Variables in Save Measure File dialog 'Output Properties'](#)
- [VSD – Possibility to create LAB files more specifically](#)
- [ES132 – Integration in INCA – CAN / CAN-FD to Ethernet](#)
- [MATLAB – Support of MATLAB 2022A](#)
- [INCA Service Pack Installer – HSP Update Tool added](#)
- [INCA-ODX – Support of OBDOnUDS](#)
- [INCA-ODX – ODX project for SAEJ1979-2 \(OBDOnUDS\)](#)

INCA V7.4 – What's New

Overview of Functionality added by Service Packs

Links to Functionality Description of Service Pack 3

- [Optimized Initialization of Devices connected to INCA](#)
- [LAB File Format V1.3 – Extended Support for Device Information](#)
- [EE – Deactivating a \(XCP-\) Connection without closing INCA or EE](#)
- [ES882.2, ES891.2 and ES892.2 – Support of 8MBaud](#)
- [INCA-SIP – Advanced GUI for "MDF Write"](#)
- [INCA-SIP – Support of Shared Configurations](#)
- [MATLAB – Support of MATLAB 2022B](#)
- [MCE – iLinkRT V3.0 - IPv6](#)

INCA V7.4 – What's New

Overview of Functionality added by Service Packs

Links to Functionality Description of Service Pack 4

- [LAB File - UI Improvements](#)
- [LAB File - Handling](#)
- [VNET – Support CAN/CAN-FD Monitoring](#)
- [VNET – Bus Monitoring parallel with XCPSimTime on Ethernet](#)
- [INCA – Use Windows default browser](#)
- [Dynamic link in the HWC to Web-Interface of ETAS devices](#)
- [AUTOSAR – LIN support](#)
- [ETK / XETK / FETK](#)
- [Import – Add Icons to the Import Overview](#)
- [VSD – Open with the focus on the currently selected widget](#)
- [ODX – OBD GUI support for OBDonUDS \(SAE J1979-2\)](#)

INCA V7.4 – What's New

Overview of Functionality added by Service Packs

Links to Functionality Description of Service Pack 5

- [MDF – Array Index without Underline](#)
- [XCP on CAN + XCP on ETH – Busload Calculation for STATIC DAQ](#)
- [AUTOSAR – Extended support of SocketConnectionIpdIdentifier](#)
- [Editors – Sort by Device](#)
- [VSD – Select all recorders in Variable Configuration Tab](#)
- [DBB – Navigate to assigned Project in DB-View](#)
- [HWC – De-assign Project](#)
- [HWC – Assign Project Dialog improvements - provide “search for Project” functionality](#)
- [HWC – Allow to deactivate automatic HW Re-Init after Flashing](#)
- [MATLAB – Support of MATLAB 2023A](#)
- [INCA-ODX – OBD GUI support for OBDonUDS \(SAE J1979-2\) and ZEVonUDS \(SAE J1979-3\)](#)

INCA V7.4 – What's New

Overview of Functionality added by Service Packs

Links to Functionality Description of Service Pack 6

- [EE – Battery cell imbalance evaluation table instrument](#)
- [MACsec support for SOME/IP and Ethernet Monitoring](#)
- [Vector VX1161 Integration in INCA](#)
- [XCP on ETH - Flat List of all Transport Layers](#)
- [INCA Service Pack Installer – Add-on RDE added](#)
- [INCA Service Pack Installer – Add-on EV Instruments added](#)

INCA V7.4 – What's New

Overview of Functionality added by Service Packs

Links to Functionality Description of Service Pack 7

- [INCA - Stop Windows shut down](#)
- [EE – Battery cell imbalance graph evaluation table instrument](#)
- [VSD - Improved display of measure array selection states](#)
- [Export for DAQ based measurement configuration](#)
- [CAN XL support](#)
- [ODX - Updated OBDonCAN and OBDonUDS ODX projects supporting SAEJ1979-DA 2022-03](#)
- [INCA Service Pack Installer – AddOn CAN-Trace added](#)
- [SOME/IP Service Discovery for Measurement](#)
- [MATLAB – Support of MATLAB 2023B](#)

General Data Protection Regulation

Compliance to General Data Protection Regulation

Please note that personal data is processed when using INCA. As the controller, the purchaser undertakes to ensure the legal conformity of these processing activities in accordance with Art. 4 No. 7 of the General Data Protection Regulation (GDPR). As the manufacturer, ETAS GmbH is not liable for any mishandling of this data.

Data categories

Please note that INCA particularly records the following personal data (categories), and/or data (categories) that can be traced back to a specific individual, for the purposes of assisting with troubleshooting

- Communication data: IP address, date and time
- User data: The user's Windows UserID

Further information to this topic is available in the INCA installation handbook and the INCA online help.

INCA Training

Seminars offered at ETAS Locations Worldwide or at Customer Site

Deep skills and sound knowledge are essential prerequisites for handling software tools of ever-rising complexity. Our trainers are highly experienced engineers in the field of engineering and support, who relish sharing knowledge on ETAS products and development processes. Target groups for the trainings are beginners, advanced users and those who wish to expand their existing knowledge. All trainings are offered at the ETAS Academy or on site at the customer´s. INCA Application is offered as presence or online training.

INCA – Application (3 days)

- Practical operation of the software and the knowledge of the INCA fundamentals
- Get to know the advantages and disadvantages of various calibration concepts

INCA - Advanced Calibration Techniques (2 days)

- Advanced functionalities in INCA, Tips & Tricks. INCA experience is required
- EHANDBOOK Navigator, INCA Flow

INCA - FLOW Coaching

- Using your own calibration tasks to see the benefits of INCA-Flow in your daily work

Some ETAS local offices have their own training programs which are specialized for the local needs. Please contact our local office of your area for the details: <https://www.etas.com/en/trainings.php>

Virtual Machines

Usage of virtual PC Machines

The usage of INCA on a virtual machine (VM) is restricted and not recommended:

- The VM needs sufficient working memory (RAM), otherwise the performance of INCA goes down
- Access to sufficient graphic card memory (Direct X) is necessary, otherwise the oscilloscope representation of measurement signal is not possible
- Access to hardware interfaces Ethernet, USB, PCMCIA, ... is necessary, otherwise INCA cannot use the connected hardware
- Measure samples may be lost and the accuracy of time stamps is not guaranteed as the higher task priority for hardware access (Target Server) is not given
- ETAS does no special tests concerning VM machines

ETAS recommends to use real PC hardware.

INCA V7.4 – What's New

Licensing

Machine Based Licenses – Shift from FlexNet Publisher to FlexNet Embedded

Step-by-step for a smooth migration



Further information about User Based and Floating licenses will be published in the course of this year

INCA V7.4 – What's New

System Requirements

Minimum System Requirements

- 2 GHz Processor, 2 GB RAM, and DVD-ROM drive *)
- Graphics: at least 1024x768, 256MB RAM, 16bit color and DirectX 9

Recommended System Requirements

- 3 GHz Quad-Core Processor, 16 GB RAM, and DVD-ROM drive *)
- Graphics: at least 1280x1024, 1GB RAM, 32bit color and DirectX 9
- Windows 10 64Bit
- Investigation on performance showed
 - More Memory improves execution time of repetitive operations
 - SSD Hard disks improve the file access times

Supported OS

- Windows 8.1 64Bit
- Windows 10 64Bit (version 1803 or higher)
- Windows 10 64Bit Enterprise (LTSC 2016 or higher)
- Windows 11 64Bit
- Windows Server 2016 64Bit / 2019 64Bit

*) Needed for installation via DVD only
Not necessary when installing via network

General Notes

Additionally Installed Components	INCA V7.3	INCA V7.4
.Net-Runtime-Environment	V4.8 ¹⁾	V4.8 ¹⁾
VCxRedist (Vcredist_x86 / Vcredist_x64)	VC9+VC10+VC14	VC9+VC10+VC14
JAVA SDK Version j2sdk1.4.2_11	X ²⁾	X ²⁾
Perl V5.30.0	X	X
ETAS Certificate	X	X
Direct X	V9 (or higher)	V9 (or higher)
ETASShared	13	14
Windows 8.1 64Bit	X ^{3) 5)}	X ^{3) 5)}
Windows 10 64Bit	X ³⁾	X ³⁾
Windows 11 64Bit	-	X
Windows Server 2016 64Bit / 2019 64Bit	X ⁴⁾	X
Windows Server 2022 64Bit	-	X ⁶⁾
¹⁾ This component is installed only when no or an older version is installed. If a newer version is already installed, it will not be touched. This is checked by a Microsoft installation routine. ²⁾ This component is installed only with ODX LINK ³⁾ For hardware driver support see release notes ⁴⁾ Starts with INCA V7.3 SP4; INCA FLOW, INCA RDE is not released for Windows Server ⁵⁾ .NET V4.8 needed (available from Microsoft Support .NET V4.8) ⁶⁾ beginning with INCA V7.4 SP2		

Thank you